

Service Manual

Inverter Pair Wall Mounted Type H-Series



[Applied Models]

- Inverter Pair : Cooling Only
- Inverter Pair : Heat Pump

Inverter Pair Wall Mounted Type H-Series

●Cooling Only

Indoor Unit

FTXS30HVJU
FTXS36HVJU

Outdoor Unit

RKS30HVJU
RKS36HVJU

●Heat Pump

Indoor Unit

FTXS30HVJU
FTXS36HVJU

Outdoor Unit

RXS30HVJU
RXS36HVJU

1. Safety Considerations	vi
--------------------------------	----

Part 1

List of Functions	1
--------------------------------	----------

1. Functions.....	2
-------------------	---

Part 2

Specifications	3
-----------------------------	----------

1. Specifications	4
1.1 Cooling Only / 60 Hz, 208 - 230 V	4
1.2 Heat Pump / 60 Hz, 208 - 230 V	5

Part 3**Printed Circuit Board****Connector Wiring Diagram6**

1. Indoor Unit.....	7
2. Outdoor Unit.....	10

Part 4**Function and Control12**

1. Main Functions.....	13
1.1 Temperature Control	13
1.2 Frequency Principle.....	13
1.3 Airflow Direction Control.....	15
1.4 Fan Speed Control for Indoor Unit	17
1.5 Program Dry Operation	18
1.6 Automatic Operation.....	19
1.7 Thermostat Control.....	20
1.8 NIGHT SET Mode	21
1.9 ECONO Operation	22
1.10 INTELLIGENT EYE Operation	23
1.11 Inverter POWERFUL Operation	24
1.12 Other Functions.....	25
2. Function of Thermistor	26
3. Control Specification	27
3.1 Mode Hierarchy	27
3.2 Frequency Control.....	28
3.3 Controls at Mode Changing / Start-up.....	30
3.4 Discharge Pipe Temperature Control.....	32
3.5 Input Current Control.....	33
3.6 Freeze-up Protection Control	34
3.7 Heating Peak-cut Control	34
3.8 Outdoor Fan Control.....	35
3.9 Liquid Compression Protection Function.....	35
3.10 Defrost Control	36
3.11 Electronic Expansion Valve Control	37
3.12 Malfunctions	40

Part 5**Operation Manual..... 41**

1. System Configuration.....	42
2. Operation Manual.....	43
2.1 Remote Controller	43
2.2 AUTO · DRY · COOL · HEAT · FAN Operation	45
2.3 Adjusting the Airflow Direction.....	47

2.4	COMFORT AIRFLOW Operation	49
2.5	INTELLIGENT EYE Operation	50
2.6	POWERFUL Operation	52
2.7	OUTDOOR UNIT QUIET Operation	53
2.8	ECONO Operation	54
2.9	TIMER Operation	55
2.10	WEEKLY TIMER Operation	57

Part 6

Service Diagnosis..... 64

1.	Troubleshooting with LED	66
1.1	Indoor Unit.....	66
1.2	Outdoor Unit.....	66
2.	Problem Symptoms and Measures	67
3.	Service Check Function	68
4.	Troubleshooting	71
4.1	Error Codes and Description	71
4.2	Indoor Unit PCB Abnormality	72
4.3	Freeze-up Protection Control or Heating Peak-cut Control.....	73
4.4	Fan Motor (DC Motor) or Related Abnormality.....	75
4.5	Thermistor or Related Abnormality (Indoor Unit).....	77
4.6	Signal Transmission Error (between Indoor Unit and Outdoor Unit)	78
4.7	Unspecified Voltage (between Indoor Unit and Outdoor Unit)	80
4.8	Outdoor Unit PCB Abnormality.....	81
4.9	OL Activation (Compressor Overload)	82
4.10	Compressor Lock	83
4.11	DC Fan Lock	84
4.12	Input Overcurrent Detection	85
4.13	Four Way Valve Abnormality.....	86
4.14	Discharge Pipe Temperature Control.....	88
4.15	High Pressure Control in Cooling	89
4.16	Compressor System Sensor Abnormality	91
4.17	Position Sensor Abnormality	93
4.18	CT or Related Abnormality	95
4.19	Thermistor or Related Abnormality (Outdoor Unit).....	97
4.20	Electrical Box Temperature Rise.....	99
4.21	Radiation Fin Temperature Rise	101
4.22	Output Overcurrent Detection	103
4.23	Refrigerant Shortage	105
4.24	Low-voltage Detection or Over-voltage Detection.....	107
4.25	Signal Transmission Error on Outdoor Unit PCB	109
5.	Check	110
5.1	Thermistor Resistance Check	110
5.2	Fan Motor Connector Output Check	111
5.3	Power Supply Waveforms Check.....	111
5.4	Electronic Expansion Valve Check.....	112

5.5	Four Way Valve Performance Check	113
5.6	Inverter Unit Refrigerant System Check.....	113
5.7	“Inverter Checker” Check	114
5.8	Rotation Pulse Check on the Outdoor Unit PCB.....	116
5.9	Installation Condition Check.....	117
5.10	Discharge Pressure Check.....	118
5.11	Outdoor Fan System Check.....	118
5.12	Capacitor Voltage Check.....	119
5.13	Power Module Check	119

Part 7

Removal Procedure 120

1.	Indoor Unit.....	121
1.1	Removal of Air Filters / Front Panel	121
1.2	Removal of Front Grille	124
1.3	Removal of Electrical Box	127
1.4	Removal of PCBs	133
1.5	Removal of Horizontal Blades / Vertical Blades / Swing Motors	140
1.6	Removal of Fan Motor.....	148
1.7	Removal of Indoor Heat Exchanger	151
1.8	Removal of Fan Rotor	154
2.	Outdoor Unit.....	156
2.1	Removal of Outer Panels	156
2.2	Removal of Electrical Box	166
2.3	Removal of PCBs	170
2.4	Removal of Fan Motor.....	173
2.5	Removal of Coils / Thermistors	174
2.6	Removal of Sound Blankets	177
2.7	Removal of Compressor.....	179

Part 8

Trial Operation and

Field Settings 181

1.	Pump Down Operation.....	182
2.	Forced Cooling Operation	183
3.	Trial Operation	184
4.	Field Settings	185
4.1	Model Type Setting	185
4.2	Temperature Display Switch	185
4.3	When 2 Units are Installed in 1 Room.....	186
4.4	Facility Setting Switch (cooling at low outdoor temperature).....	187
4.5	Jumper and Switch Settings.....	187
5.	Application of Silicon Grease to a Power Transistor and a Diode Bridge.....	188





Part 9

Appendix.....	189
1. Piping Diagrams.....	190
1.1 Indoor unit	190
1.2 Outdoor Unit.....	191
2. Wiring Diagrams.....	192

1. Safety Considerations

Read these **SAFETY CONSIDERATIONS** carefully before performing any repair work. Comply with these safety symbols without fail.

Meanings of **DANGER**, **WARNING**, **CAUTION**, and **NOTE** Symbols:

-  **DANGER** Indicates an imminently hazardous situation which, if not avoided, will result in death or serious injury.
-  **WARNING** Indicates a potentially hazardous situation which, if not avoided, could result in death or serious injury.
-  **CAUTION** Indicates a potentially hazardous situation which, if not avoided, may result in minor or moderate injury. It may also be used to alert against unsafe practices.
-  **NOTE** Indicates situations that may result in equipment or property-damage accidents only.

1.1 Safety Considerations for Repair

- If refrigerant gas leaks during repair or service, ventilate the area immediately. Refrigerant gas may produce toxic gas if it comes into contact with flames. Refrigerant gas is heavier than air and replaces oxygen. In the event of an accident, a massive leak could lead to oxygen depletion, especially in basements, and an asphyxiation hazard could occur leading to serious injury or death.
- Do not start or stop the air conditioner or heat pump operation by plugging or unplugging the power cable plug if a plug is used. Plugging or unplugging the power cable plug to operate the equipment may cause an electrical shock or fire.
- Use parts listed in the service parts list and appropriate tools to conduct repair work. The use of inappropriate parts or tools may cause an electrical shock or fire.
- Disconnect power before disassembling the equipment for repairs. Working on the equipment that is connected to the power supply may cause an electric shock. If it is necessary to supply power to the equipment to conduct repairs or to inspect the circuits, do not touch any electrically charged sections of the equipment.
- The step-up capacitor supplies high-voltage electricity to the electrical components of the outdoor unit. Discharge the capacitor completely before conducting repair work. A charged capacitor may cause an electrical shock.
- If refrigerant gas is discharged during repair work, do not touch the discharged refrigerant gas. The refrigerant gas may cause frostbite.
- Use only pipes, flare nuts, tools, and other materials designed specifically for R410A refrigerant systems. Never use tools or materials designed for R22 refrigerant systems on an R410A refrigerant system. Doing so can cause a serious accident or an equipment failure.
- Check to see if the parts and wires are mounted and connected properly, and if the connections at the soldered or crimped terminals are secure. Improper installation and connections may cause excessive heat generation, fire, or electrical shock.
- Prior to disconnecting the suction or discharge pipe from the compressor at the welded section, pump-down the refrigerant gas completely in a well-ventilated place first. If there is refrigerant gas or oil remaining inside the compressor, the refrigerant gas or oil can discharge when the pipe is being disconnected and it may cause an injury.
- Wear a safety helmet, gloves, and a safety belt when working at an elevated height of more than 6.5 ft (2 m). Insufficient safety measures may cause a fall resulting in injury.
- Do not mix air or gas other than the specified refrigerant R410A to the refrigerant system. If air enters the refrigerant systems, it can cause an excessive high pressure resulting in equipment damage and injury.
- When relocating the equipment, check if the new installation site has sufficient strength to withstand the weight of the equipment. If the installation site does not have sufficient strength and the equipment is not properly secured, the equipment may fall and cause injury.
- Securely fasten the outside unit terminal cover (panel). If the terminal cover/panel is not fastened properly, dust or water may enter the outside unit causing fire or electric shock.
- When relocating the system, keep the refrigerant circuit free from substances other than the specified refrigerant (R-410A) such as air. Any presence of air or other foreign substance in the refrigerant circuit can cause an abnormal pressure rise or rupture, resulting in injury.
- If refrigerant gas leaks, locate the leaking point and repair it before charging refrigerant. After charging refrigerant, check for refrigerant leaks. If the leaking point cannot be located and the repair work must be stopped, perform a pump-down and close the service valve to prevent the refrigerant gas from leaking into the room. The refrigerant gas itself is harmless, but it

- may generate toxic gases if it comes into contact with flames.
- Do not repair the electrical components with wet hands. Working on the equipment with wet hands may cause an electrical shock.
 - Do not clean the air conditioner or heat pump by splashing water on it. Washing the unit with water may cause an electrical shock.
 - Turn off the power when cleaning the equipment to prevent internal fans that rotate at high speed from starting suddenly as they can cause injury.
 - Let the refrigerant lines cool down before performing any repair work. Working on the unit when the refrigerant lines are hot may cause burns.
 - All welding and cutting operations must be done in a well-ventilated place to prevent the accumulation of toxic fumes or possibly oxygen deficiency to occur.
 - Check the grounding before repairing equipment in a humid or wet place to avoid electrical shocks. Improper grounding may cause an electrical shock.
 - Measure the insulation resistance after the repair. The resistance must be $1\text{M}\Omega$ or higher. Faulty insulation may cause an electrical shock.
 - Check the drainage of the indoor unit after finishing repair work. Faulty drainage may cause water to enter the room resulting in wet floors and furniture.
 - Do not tilt the unit when removing it. The water inside the unit may spill resulting in wet floors and furniture.
 - Dismantling of the unit, disposal of the refrigerant, oil, and additional parts, should be done in accordance with the relevant local, state, and national regulations.
- Check the unit foundation for damage on a continual basis, especially if it has been in use for a long time. If left in a damaged condition, the unit may fall and cause injury. If the installation platform or frame has corroded, have it replaced. A corroded platform or frame may cause the unit to fall resulting in injury.
 - If the unit has a power cable plug and it is dirty, clean the plug before securely inserting it into a power outlet. If the plug has a loose connection, tighten it or it may cause electrical shock or fire.
 - After replacing the battery in the remote controller, dispose of the old battery to prevent children from swallowing it. If a child swallows the battery, see a doctor immediately.
 - Never remove the fan guard of the unit. A fan rotating at high speed without the fan guard is very dangerous.
 - Before cleaning the unit, stop the operation of the unit by turning the power off or by pulling the power cable plug out from its receptacle. Otherwise an electrical shock or injury may result.
 - Do not wipe the controller operation panel with benzene, thinner, chemical dust cloth, etc. The panel may get discolored or the coating can peel off. If it is extremely dirty, soak a cloth in a water-diluted neutral detergent, squeeze it well, and wipe the panel clean. Then wipe it with another dry cloth.

1.2 Safety Considerations for Users

- Never attempt to modify the equipment. Doing so can cause electrical shock, excessive heat generation, or fire.
- If the power cable and lead wires have scratches or have become deteriorated, have them replaced. Damaged cable and wires may cause an electrical shock or fire.
- Do not use a joined power cable or an extension cord, or share the same power outlet with other electrical appliances as it may cause an electrical shock or fire.
- Use an exclusive power circuit for the equipment. Insufficient circuit amperage capacity may cause an electrical shock or fire.
- Do not damage or modify the power cable. Damaged or modified power cables may cause an electrical shock or fire. Placing heavy items on the power cable or pulling the power cable may damage the cable.

Part 1

List of Functions

1. Functions.....2

1. Functions

Category	Functions	FTXS30/36HVJU RKS30/36HVJU	FTXS30/36HVJU RXS30/36HVJU	Category	Functions	FTXS30/36HVJU RKS30/36HVJU	FTXS30/36HVJU RXS30/36HVJU
Basic Function	Inverter (with Inverter Power Control)	●	●	Health & Clean	Air-Purifying Filter	—	—
	Operation Limit for Cooling (°FDB)	14~114.8	14~114.8		Photocatalytic Deodorizing Filter	—	—
	Operation Limit for Heating (°FWB)	—	5~75		Air-Purifying Filter with Photocatalytic Deodorizing Function	—	—
	PAM Control	●	●		Titanium Apatite Photocatalytic Air-Purifying Filter	●	●
Compressor	Oval Scroll Compressor	—	—	Timer	Air Filter (Prefilter)	●	●
	Swing Compressor	●	●		Wipe-Clean Flat Panel	●	●
	Rotary Compressor	—	—		Washable Grille	—	—
	Reluctance DC Motor	●	●		MOLD PROOF Operation	—	—
Comfortable Airflow	Power-Airflow Louver (Horizontal Blade)	—	—	Worry Free "Reliability & Durability"	Heating Dry Operation	—	—
	Power-Airflow Dual Louvers	●	●		Good-Sleep Cooling Operation	—	—
	Power-Airflow Diffuser	—	—		WEEKLY TIMER	●	●
	Wide-Angle Fins (Vertical Blades)	●	●		24-Hour ON/OFF TIMER	●	●
	Vertical Auto-Swing (Up and Down)	●	●		NIGHT SET Mode	●	●
	Horizontal Auto-Swing (Right and Left)	●	●		Auto-Restart (after Power Failure)	●	●
	3-D Airflow	●	●		Self-Diagnosis (Digital, LED) Display	●	●
COMFORT AIRFLOW Operation	●	●	Wiring Error Check Function	—	—		
Comfort Control	Auto Fan Speed	●	●	Flexibility	Anti-Corrosion Treatment of Outdoor Heat Exchanger	●	●
	Indoor Unit Quiet Operation	●	●		Multi-Split / Split Type Compatible Indoor Unit	—	—
	NIGHT QUIET Mode (Automatic)	—	—		H/P, C/O Compatible Indoor Unit	●	●
	Outdoor Unit Quiet Operation (Manual)	●	●		Flexible Power Supply Correspondence	—	—
	INTELLIGENT EYE Operation	●	●		Chargeless	32 ft	32 ft
	Quick Warming Function (Preheating Operation)	—	●		Either Side Drain (Right or Left)	●	●
	Hot-Start Function	—	●		Power Selection	—	—
Operation	Automatic Defrosting	—	●	Remote Control	Low Temperature Cooling Operation (-15°C) (5°F)	●	●
	Automatic Operation	—	●		°F/°C Changeover R/C Temperature Display (factory setting: °F)	●	●
	Program Dry Function	●	●		5-Room Centralized Controller (Option)	●	●
Lifestyle Convenience	Fan Only	●	●	Remote Controller	Remote Control Adaptor (Normal Open Pulse Contact) (Option)	●	●
	New POWERFUL Operation (Non-Inverter)	—	—		Remote Control Adaptor (Normal Open Contact) (Option)	●	●
	Inverter POWERFUL Operation	●	●		DIII-NET Compatible (Adaptor) (Option)	●	●
	Priority-Room Setting	—	—	Wireless	●	●	
	COOL / HEAT Mode Lock	—	—	Wired (Option)	●	●	
	HOME LEAVE Operation	—	—				
	ECONO Operation	●	●				
	Indoor Unit ON/OFF Button	●	●				
	Signal Receiving Sign	●	●				
R/C with Back Light	●	●					
Temperature Display	—	—					

Note: ● : Holding Functions
 — : No Functions

Part 2 Specifications

1. Specifications4

1. Specifications

1.1 Cooling Only / 60 Hz, 208 - 230 V

Model	Indoor Unit		FTXS30HVJU	FTXS36HVJU
	Outdoor Unit		RKS30HVJU	RKS36HVJU
Capacity Rated (Min. ~ Max.)	kW		8.8 (3.0 ~ 8.8)	10.2-10.5 (3.0 ~ 10.2-10.5)
	Btu/h		30,000 (10,200 ~ 30,000)	35,000-36,000 (10,200 ~ 35,000-36,000)
	kcal/h		7,570 (2,580 ~ 7,570)	8,770-9,030 (2,580 ~ 8,770-9,030)
Running Current (Rated)	A		13.6-12.2	19.4-18.8
Power Consumption Rated (Min. ~ Max.)	W		2,800 (620 ~ 2,800)	4,000-4,300 (620 ~ 4,000-4,300)
Power Factor (Rated)	%		99.0-99.8	99.1-99.4
COP (Rated)	W/W		3.14 (4.84 ~ 3.14)	2.55-2.44 (4.84 ~ 2.55-2.44)
SEER (Rated)			17.0	16.2
EER (Rated)	Btu/h-W		10.71 (16.45 ~ 10.71)	8.75-8.37 (16.45 ~ 8.75-8.37)
Piping Connections	Liquid	inch (mm)	ϕ 3/8 (ϕ 9.5)	ϕ 3/8 (ϕ 9.5)
	Gas	inch (mm)	ϕ 5/8 (ϕ 15.9)	ϕ 5/8 (ϕ 15.9)
	Drain	inch (mm)	ϕ 1 1/16 (ϕ 18.0)	ϕ 1 1/16 (ϕ 18.0)
Heat Insulation			Both Liquid and Gas Pipes	Both Liquid and Gas Pipes
Max. Interunit Piping Length	feet (m)		98.4 (30)	98.4 (30)
Max. Interunit Height Difference	feet (m)		65.6 (20)	65.6 (20)
Chargeless	feet (m)		32 (10)	32 (10)
Amount of Additional Charge of Refrigerant	oz/ft (g/m)		0.55 (50)	0.55 (50)
Indoor Unit			FTXS30HVJU	FTXS36HVJU
Front Panel Color			White	White
Airflow Rate	H	cfm (m³/min)	706 (20.0)	770 (21.8)
	M		611 (17.3)	635 (18.0)
	L		519 (14.7)	519 (14.7)
	SL		473 (13.4)	473 (13.4)
Fan	Type		Cross Flow Fan	Cross Flow Fan
	Motor Output	W	64	64
	Speed	Steps	5 Steps, Quiet, Auto	5 Steps, Quiet, Auto
Air Direction Control			Right, Left, Horizontal, Downward	Right, Left, Horizontal, Downward
Air Filter			Removable / Washable / Mildew Proof	Removable / Washable / Mildew Proof
Running Current (Rated)	A		0.38 - 0.34	0.38 - 0.34
Power Consumption (Rated)	W		77	77
Power Factor (Rated)	%		97.4 - 98.5	97.4 - 98.5
Temperature Control			Microcomputer Control	Microcomputer Control
Dimensions (H x W x D)	inch (mm)		13-3/8 x 47-1/4 x 9-7/16 (340 x 1,200 x 240)	13-3/8 x 47-1/4 x 9-7/16 (340 x 1,200 x 240)
Packaged Dimensions (H x W x D)	inch (mm)		12-13/16 x 51-9/16 x 16-7/8 (325 x 1,310 x 429)	12-13/16 x 51-9/16 x 16-7/8 (325 x 1,310 x 429)
Weight	Lbs (kg)		38 (17)	38 (17)
Gross Weight	Lbs (kg)		51 (23)	51 (23)
Operation Sound	H / M / L / SL	dB(A)	47 / 45 / 40 / 37	49 / 45 / 40 / 37
Sound Power	dB(A)		63	65
Outdoor Unit			RKS30HVJU	RKS36HVJU
Casing Color			Ivory White	Ivory White
Compressor	Type		Hermetically Sealed Swing Type	Hermetically Sealed Swing Type
	Model		2YC63HXD	2YC63HXD
Refrigerant Oil	Motor Output	W	2,030	2,030
	Type		FVC50K	FVC50K
Refrigerant	Charge	oz (g)	25.5 (723)	25.5 (723)
	Type		R-410A	R-410A
Airflow Rate	HH	cfm (m³/min)	2,867 (81.2)	2,867 (81.2)
	H		2,627 (74.4)	2,627 (74.4)
SL	2,316 (65.6)		2,316 (65.6)	
Fan	Type		Propeller	Propeller
	Motor Output	W	200	200
Running Current (Rated)	A		13.22 - 11.86	19.02 - 18.46
Power Consumption (Rated)	W		2,723 - 2,723	3,923 - 4,223
Power Factor (Rated)	%		99.0 - 99.8	99.2 - 99.5
Starting Current	A		18.9	19.4
Dimensions (H x W x D)	inch (mm)		38-15/16 x 37 x 12-5/8 (990 x 940 x 320)	38-15/16 x 37 x 12-5/8 (990 x 940 x 320)
Packaged Dimensions (H x W x D)	inch (mm)		44-1/8 x 38 x 15-1/4 (1,120 x 966 x 388)	44-1/8 x 38 x 15-1/4 (1,120 x 966 x 388)
Weight	Lbs (kg)		178 (81)	178 (81)
Gross Weight	Lbs (kg)		198 (90)	198 (90)
Operation Sound	H / SL	dB(A)	54 / 51	54 / 51
Sound Power	dB(A)		68	68
Drawing No.			3D072241	3D072242

■ The data are based on the conditions shown in the following table:

Indoor ;	Cooling	Piping Length
80°FDB (27°CDB) 67°FWB (19.4°CWB) Outdoor ; 95°FDB (35°CDB) 75°FWB (24°CWB)		25 ft (7.5 m)

Conversion Formulae
kcal/h = kW x 860
Btu/h = kW x 3412
cfm = m³/min x 35.3

1.2 Heat Pump / 60 Hz, 208 - 230 V

Model	Indoor Unit		FTXS30HVJU		FTXS36HVJU	
	Outdoor Unit		RXS30HVJU		RXS36HVJU	
			Cooling	Heating	Cooling	Heating
Capacity Rated (Min. ~ Max.)	kW		8.8 (3.0 ~ 8.8)	10.2 (3.0 ~ 10.2)	10.2-10.5 (3.0 ~ 10.2-10.5)	10.5-11.1 (3.0 ~ 10.5-11.1)
	Btu/h		30,000 (10,200 ~ 30,000)	34,800 (10,200 ~ 34,800)	35,000-36,000 (10,200 ~ 35,000-36,000)	36,000-38,000 (10,200 ~ 36,000-38,000)
	kcal/h		7,570 (2,580 ~ 7,570)	8,770 (2,580 ~ 8,770)	8,770-9,030 (2,580 ~ 8,770-9,030)	9,030-9,550 (2,580 ~ 9,030-9,550)
Running Current (Rated)	A		13.6-12.2	18.9-17.1	19.4-18.8	18.4-18.4
Power Consumption Rated (Min. ~ Max.)	W		2,800 (620 ~ 2,800)	3,900 (620 ~ 3,900)	4,000-4,300 (620 ~ 4,000-4,300)	3,800-4,200 (620 ~ 3,800-4,200)
Power Factor (Rated)	%		99.0-99.8	99.2-99.2	99.1-99.4	99.3-99.2
COP (Rated)	W/W		3.14 (4.84 ~ 3.14)	2.62 (4.84 ~ 2.62)	2.55-2.44 (4.84 ~ 2.55-2.44)	2.76-2.64 (4.84 ~ 2.76-2.64)
SEER (Rated)			17.0	17.0	16.2	16.2
EER (Rated)	Btu/h-W		10.71 (16.45 ~ 10.71)	8.92 (16.45 ~ 8.92)	8.75-8.37 (16.45 ~ 8.75-8.37)	9.47-9.05 (16.45 ~ 9.47-9.05)
Piping Connections	Liquid	inch (mm)	φ 3/8 (φ 9.5)		φ 3/8 (φ 9.5)	
	Gas	inch (mm)	φ 5/8 (φ 15.9)		φ 5/8 (φ 15.9)	
	Drain	inch (mm)	φ 11/16 (φ 18.0)		φ 11/16 (φ 18.0)	
Heat Insulation			Both Liquid and Gas Pipes		Both Liquid and Gas Pipes	
Max. Interunit Piping Length		feet (m)	98.4 (30)		98.4 (30)	
Max. Interunit Height Difference		feet (m)	65.6 (20)		65.6 (20)	
Chargeless		feet (m)	32 (10)		32 (10)	
Amount of Additional Charge of Refrigerant		oz/ft (g/m)	0.55 (50)		0.55 (50)	
Indoor Unit			FTXS30HVJU		FTXS36HVJU	
Front Panel Color			White		White	
Airflow Rate	H	cfm (m³/min)	706 (20.0)	710 (20.1)	770 (21.8)	808 (22.9)
	M		611 (17.3)	611 (17.3)	635 (18.0)	657 (18.6)
	L		519 (14.7)	519 (14.7)	519 (14.7)	519 (14.7)
	SL		473 (13.4)	469 (13.3)	473 (13.4)	469 (13.3)
Fan	Type	Cross Flow Fan		Cross Flow Fan		
	Motor Output	W	64		64	
	Speed	Steps	5 Steps, Quiet, Auto		5 Steps, Quiet, Auto	
Air Direction Control			Right, Left, Horizontal, Downward		Right, Left, Horizontal, Downward	
Air Filter			Removable / Washable / Mildew Proof		Removable / Washable / Mildew Proof	
Running Current (Rated)	A	0.38 - 0.34	0.38 - 0.34	0.38 - 0.34	0.38 - 0.34	
Power Consumption (Rated)	W	77	77	77	77	
Power Factor (Rated)	%	97.4 - 98.5	97.4 - 98.5	97.4 - 98.5	97.4 - 98.5	
Temperature Control			Microcomputer Control		Microcomputer Control	
Dimensions (H x W x D)		inch (mm)	13-3/8 x 47-1/4 x 9-7/16 (340 x 1,200 x 240)		13-3/8 x 47-1/4 x 9-7/16 (340 x 1,200 x 240)	
Packaged Dimensions (H x W x D)		inch (mm)	12-13/16 x 51-9/16 x 16-7/8 (325 x 1,310 x 429)		12-13/16 x 51-9/16 x 16-7/8 (325 x 1,310 x 429)	
Weight		Lbs (kg)	38 (17)		38 (17)	
Gross Weight		Lbs (kg)	51 (23)		51 (23)	
Operation Sound	H / M / L / SL	dB(A)	47 / 45 / 40 / 37	47 / 44 / 38 / 35	49 / 45 / 40 / 37	49 / 44 / 38 / 35
Sound Power		dB(A)	63	63	65	65
Outdoor Unit			RXS30HVJU		RXS36HVJU	
Casing Color			Ivory White		Ivory White	
Compressor	Type	Hermetically Sealed Swing Type		Hermetically Sealed Swing Type		
	Model	2YC63HXD		2YC63HXD		
Motor Output		W	2,030		2,030	
Refrigerant Oil	Type	FVC50K		FVC50K		
	Charge	oz (g)	25.5 (723)		25.5 (723)	
Refrigerant	Type	R-410A		R-410A		
	Charge	Lbs (kg)	6.17 (2.8)		6.17 (2.8)	
Airflow Rate	HH	cfm (m³/min)	2,867 (81.2)	—	2,867 (81.2)	—
	H		2,627 (74.4)	2,627 (74.4)	2,627 (74.4)	2,627 (74.4)
	SL		2,316 (65.6)	2,316 (65.6)	2,316 (65.6)	2,316 (65.6)
Fan	Type	Propeller		Propeller		
	Motor Output	W	200		200	
Running Current (Rated)	A	13.22 - 11.86	18.52 - 16.76	19.02 - 18.46	18.02 - 18.06	
Power Consumption (Rated)	W	2,723 - 2,723	3,823 - 3,823	3,923 - 4,223	3,723 - 4,123	
Power Factor (Rated)	%	99.0 - 99.8	99.2 - 99.2	99.2 - 99.5	99.3 - 99.3	
Starting Current	A	18.9		19.4		
Dimensions (H x W x D)		inch (mm)	38-15/16 x 37 x 12-5/8 (990 x 940 x 320)		38-15/16 x 37 x 12-5/8 (990 x 940 x 320)	
Packaged Dimensions (H x W x D)		inch (mm)	44-1/8 x 38 x 15-1/4 (1,120 x 966 x 388)		44-1/8 x 38 x 15-1/4 (1,120 x 966 x 388)	
Weight		Lbs (kg)	178 (81)		178 (81)	
Gross Weight		Lbs (kg)	198 (90)		198 (90)	
Operation Sound	H / SL	dB(A)	54 / 51	55 / 51	54 / 51	55 / 51
Sound Power	H	dB(A)	68	69	68	69
Drawing No.			3D063298A		3D063299A	

■ The data are based on the conditions shown in the following table:

Cooling		Heating		Piping Length
Indoor ; 80°FDB (27°CDB)	67°FWB (19.4°CWB)	Indoor ; 70°FDB (21°CDB)	60°FWB (15.5°CWB)	25 ft (7.5 m)
Outdoor ; 95°FDB (35°CDB)	75°FWB (24°CWB)	Outdoor ; 47°FDB (8.3°CDB)	43°FWB (6°CWB)	

Conversion Formulae
kcal/h = kW x 860
Btu/h = kW x 3412
cfm = m³/min x 35.3

Part 3 Printed Circuit Board Connector Wiring Diagram

1. Indoor Unit.....	7
2. Outdoor Unit.....	10

1. Indoor Unit

Connectors and Other Parts

PCB (1): Control PCB

- | | |
|----------------------|---|
| 1) S1 | Connector for DC fan motor |
| 2) S21 | Connector for centralized control (HA) |
| 3) S25 | Connector for INTELLIGENT EYE sensor PCB |
| 4) S32 | Indoor heat exchanger thermistor |
| 5) S41 | Connector for swing motors |
| 6) S46 | Connector for display PCB |
| 7) S47 | Connector for signal receiver PCB |
| 8) H1, H2, H3,
FG | Connector for terminal board |
| 9) V1 | Varistor |
| 10) JA | Address setting jumper
* Refer to page 186 for detail. |
| JB | Fan speed setting when compressor stops for thermostat OFF |
| JC | Power failure recovery function (auto-restart)
* Refer to page 187 for detail. |
| 11) LED A | LED for service monitor (green) |
| 12) FU1 (F1U) | Fuse (3.15 A, 250 V) |

PCB (2): Signal Receiver PCB

- | | |
|--------|---------------------------|
| 1) S48 | Connector for control PCB |
|--------|---------------------------|

PCB (3): Display PCB

- | | |
|---------------|--|
| 1) S49 | Connector for control PCB |
| 2) SW1 | Forced cooling operation ON/OFF button |
| 3) LED1 (H1P) | LED for operation (green) |
| 4) LED2 (H2P) | LED for timer (yellow) |
| 5) LED3 (H3P) | LED for INTELLIGENT EYE (green) |
| 6) RTH1 (R1T) | Room temperature thermistor |

PCB (4): INTELLIGENT EYE Sensor PCB

- | | |
|--------|---------------------------|
| 1) S36 | Connector for control PCB |
|--------|---------------------------|

PCB (2): Signal Receiver PCB

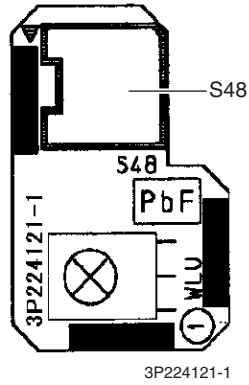

PCB (3): Display PCB

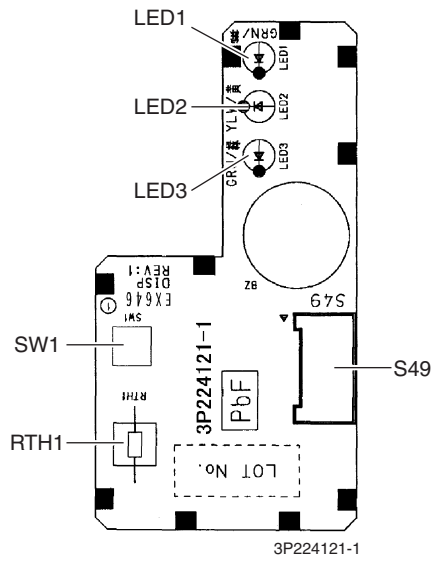

PCB (4): INTELLIGENT EYE Sensor PCB

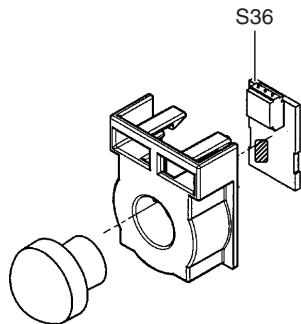

3P227885-1

2. Outdoor Unit

Connectors and Other Parts

PCB (1): Main PCB

1) S10	Connector for terminal board (indoor - outdoor transmission)
2) S20	Connector for electronic expansion valve coil
3) S40	Connector for overload protector
4) S51, S101	Connector for service monitor PCB
5) S70	Connector for fan motor
6) S80	Connector for four way valve coil
7) S90	Connector for thermistors (outdoor temperature, outdoor heat exchanger, discharge pipe)
8) AC1, AC2	Connector for terminal board (power supply)
9) E1, E2	Connector for earth
10) HR1, HR2	Connector for reactor
11) U, V, W	Connector for compressor
12) FU1	Fuse (30 A, 250 V)
13) FU2, FU3	Fuse (3.15 A, 250 V)
14) V2, V3, V5 V9, V100	Varistor

PCB (2): Service Monitor PCB

1) S52, S102	Connector for main PCB
2) LED A	LED for service monitor (green)
3) SW1	Forced cooling operation ON/OFF switch
4) SW4-B	Switch for facility setting * Refer to page 187 for detail
SW4-C	Switch for improvement of defrost performance * Refer to page 187 for detail.

PCB Detail

PCB (1): Main PCB

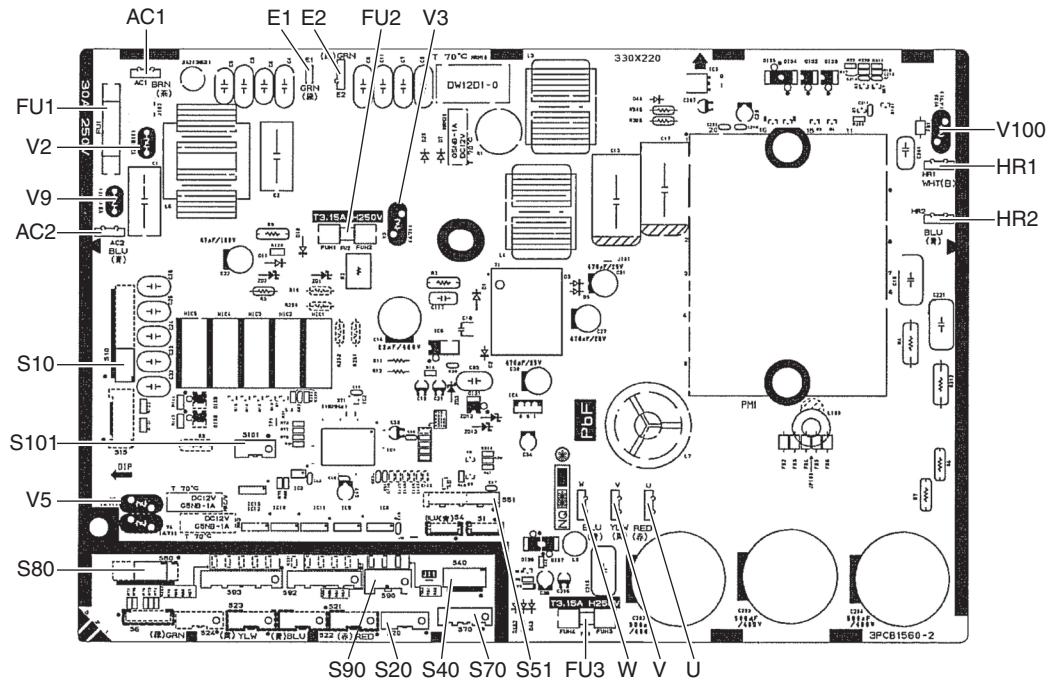

2P230094-2

PCB (2): Service Monitor PCB

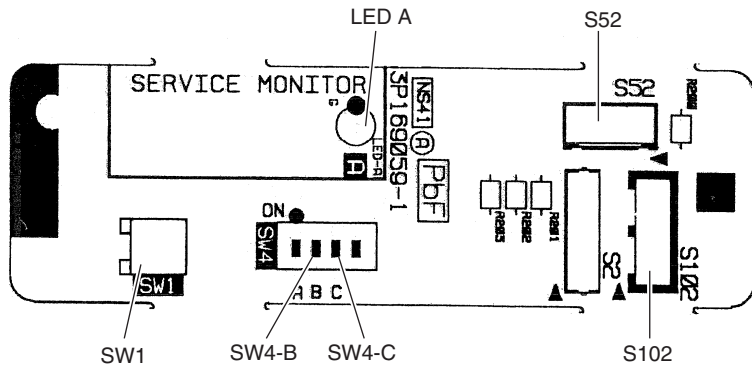

3P169059-1

★ SW4-A does not function.

Part 4

Function and Control

1. Main Functions	13
1.1 Temperature Control	13
1.2 Frequency Principle.....	13
1.3 Airflow Direction Control.....	15
1.4 Fan Speed Control for Indoor Unit	17
1.5 Program Dry Operation	18
1.6 Automatic Operation.....	19
1.7 Thermostat Control.....	20
1.8 NIGHT SET Mode	21
1.9 ECONO Operation	22
1.10 INTELLIGENT EYE Operation	23
1.11 Inverter POWERFUL Operation	24
1.12 Other Functions.....	25
2. Function of Thermistor	26
3. Control Specification	27
3.1 Mode Hierarchy	27
3.2 Frequency Control.....	28
3.3 Controls at Mode Changing / Start-up.....	30
3.4 Discharge Pipe Temperature Control.....	32
3.5 Input Current Control.....	33
3.6 Freeze-up Protection Control	34
3.7 Heating Peak-cut Control	34
3.8 Outdoor Fan Control.....	35
3.9 Liquid Compression Protection Function.....	35
3.10 Defrost Control	36
3.11 Electronic Expansion Valve Control	37
3.12 Malfunctions	40

1. Main Functions

1.1 Temperature Control

Definitions of Temperatures

The definitions of temperatures are classified as following.

- ◆ Room temperature: temperature of lower part of the room
- ◆ Set temperature: temperature set by remote controller
- ◆ Room thermistor temperature: temperature detected by room temperature thermistor
- ◆ Target temperature: temperature determined by microcomputer

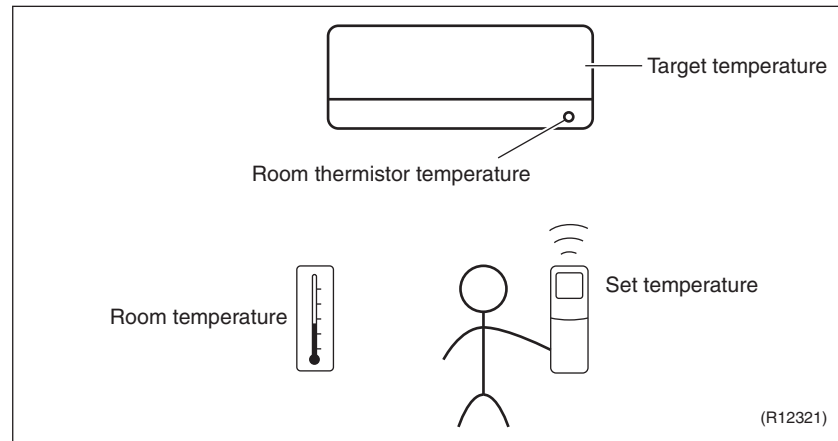

Temperature Control

The temperature of the room is detected by the room temperature thermistor. However, there is difference between the “temperature detected by room temperature thermistor” and the “temperature of lower part of the room”, depending on the type of the indoor unit or installation condition. Practically, the temperature control is done by the “target temperature appropriately adjusted for the indoor unit” and the “temperature detected by room temperature thermistor”.

1.2 Frequency Principle

Main Control Parameters

The compressor is frequency-controlled during normal operation. The target frequency is set by the following 2 parameters coming from the operating indoor unit:

- The load condition of the operating indoor unit
- The difference between the room thermistor temperature and the target temperature

Additional Control Parameters

The target frequency is adapted by additional parameters in the following cases:

- Frequency restrictions
- Initial settings
- Forced cooling operation

Inverter Principle

To regulate the capacity, a frequency control is needed. The inverter makes it possible to vary the rotation speed of the compressor. The following table explains the conversion principle:

Phase	Description
1	The supplied AC power source is converted into a DC power source.
2	The DC power source is reconverted into a three-phase AC power source with variable frequency. <ul style="list-style-type: none"> ■ When the frequency increases, the rotation speed of the compressor increases resulting in increased refrigerant circulation. This leads to a higher amount of heat exchange per unit. ■ When the frequency decreases, the rotation speed of the compressor decreases resulting in decreased refrigerant circulation. This leads to a lower amount of heat exchange per unit.

Drawing of Inverter

The following drawing shows a schematic view of the inverter principle:

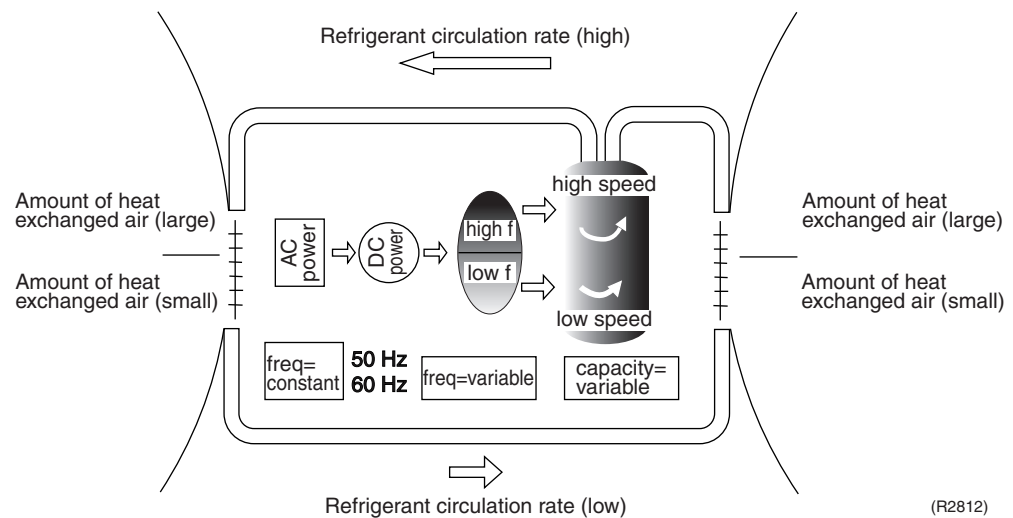

Inverter Features

The inverter provides the following features:

- The regulating capacity can be changed according to the changes in the outdoor temperature and cooling / heating load.
- Quick heating and quick cooling
The compressor rotational speed is increased when starting the heating (or cooling). This enables to reach the set temperature quickly.
- Even during extremely cold weather, high capacity is achieved. It is maintained even when the outdoor temperature is 2°C (35.6°F).
- Comfortable air conditioning
A fine adjustment is integrated to keep the room temperature constant.
- Energy saving heating and cooling
Once the set temperature is reached, the energy saving operation maintains the room temperature at low power.

Frequency Limits

The following functions regulate the minimum and maximum frequency:

Frequency	Functions
Low	<ul style="list-style-type: none"> ■ Four-way valve operation compensation. Refer to page 31.
High	<ul style="list-style-type: none"> ■ Compressor protection function. Refer to page 31. ■ Discharge pipe temperature control. Refer to page 32. ■ Input current control. Refer to page 33. ■ Freeze-up protection control. Refer to page 34. ■ Heating peak-cut control. Refer to page 34. ■ Defrost control. Refer to page 36.

Forced Cooling Operation

Refer to page 183 for detail.

1.3 Airflow Direction Control

Power-Airflow Dual Louvers

The large louvers send a large volume of air downward to the floor and provide an optimum control in cooling, dry, and heating mode.

Cooling / Dry Mode

During cooling or dry mode, the louvers retract into the indoor unit, allowing cool air to be blown across the whole room.

Heating Mode

During heating mode, the large louvers direct airflow downward to spread the warm air to the entire room.

Wide-Angle Fins

The fins, made of elastic synthetic resin, provide a wide range of airflow that guarantees a comfortable air distribution.

Auto-Swing

The following table explains the auto swing process for cooling, dry, heating, and fan:

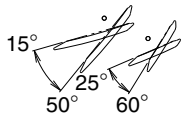
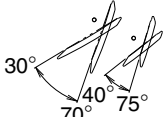
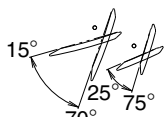
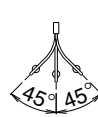
Louvers (horizontal blades) with Vertical Swing (up and down)			Fins (vertical blades) with Horizontal Swing (right and left)
Cooling / Dry	Heating	Fan	
 <p>(R9303)</p>	 <p>(R9304)</p>	 <p>(R9305)</p>	 <p>(R9306)</p>

3-D Airflow

Alternative repetition of vertical and horizontal swing motions enables uniform airconditioning of the entire room. This function is effective for starting the air conditioner.

When the horizontal swing and vertical swing are both set to auto mode, the airflow becomes 3-D airflow. The horizontal and vertical swing motions are alternated and the airflow direction changes in the order shown in the following diagram.

- (1) The vertical blades (fins) move from the right to the left.
- (2) The horizontal blades (louvers) move downward.
- (3) The vertical blades (fins) move from the left to the right.
- (4) The horizontal blades (louvers) move upward.

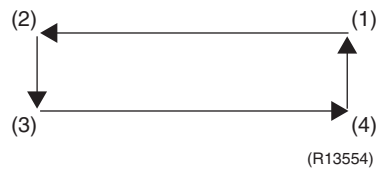
**COMFORT
AIRFLOW
Operation**

The horizontal blades (louvers) are controlled to avoid blowing air directly on people in the room.

Cooling	Heating
<p style="text-align: center;">(R9655)</p>	<p style="text-align: center;">(R9654)</p>

1.4 Fan Speed Control for Indoor Unit

Outline

Phase control and fan speed control contains 9 steps: LLL, LL, SL, L, ML, M, MH, H, and HH. The airflow rate can be automatically controlled depending on the difference between the room thermistor temperature and the target temperature. This is done through phase control and Hall IC control.



For more information about Hall IC, refer to the troubleshooting section, **Fan Motor (DC Motor) or Related Abnormality** on page 75.

Automatic Fan Speed Control

In automatic fan speed operation, the step "SL" is not available.

Step	Cooling	Heating
LLL	 (R11681)	 (R6834)
LL		
L		
ML		
M		
MH		
H		
HH (POWERFUL)		

= The airflow rate is automatically controlled within this range when the FAN setting button is set to automatic.

<Cooling>

The following drawing explains the principle of fan speed control for cooling.

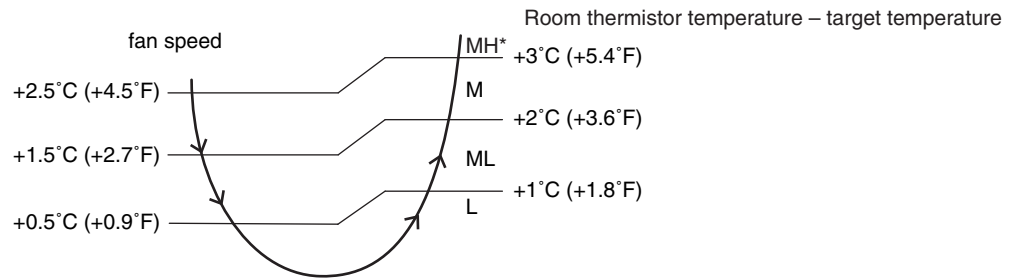

(R14449)

*In automatic fan speed operation, upper limit is at M tap within 30 minutes from the operation start.

<Heating>

In heating mode, the fan speed is regulated according to the indoor heat exchanger temperature and the difference between the room thermistor temperature and the target temperature.



Note:

1. During POWERFUL operation, fan rotates at H tap + 50 rpm.
2. Fan stops during defrost operation.

COMFORT AIRFLOW Operation

- The fan speed is controlled automatically within the following steps.
 - <Cooling>
L tap ~ MH tap (same as AUTOMATIC)
 - <Heating>
~ M tap

- The latest command has the priority between POWERFUL and COMFORT AIRFLOW.

1.5 Program Dry Operation

Outline Program dry operation removes humidity while preventing the room temperature from lowering. Since the microcomputer controls both the temperature and airflow rate, the temperature adjustment and fan adjustment buttons are inoperable in this mode.

Detail The microcomputer automatically sets the temperature and airflow rate. The difference between the room thermistor temperature at start-up and the target temperature is divided into two zones. Then, the unit operates in the dry mode with an appropriate capacity for each zone to maintain the temperature and humidity at a comfortable level.

Room thermistor temperature at start-up	Target temperature X	Thermostat OFF point Y	Thermostat ON point Z
24°C (75.2°F) or more	Room thermistor temperature at start-up	$X - 2.5^{\circ}\text{C} (-4.5^{\circ}\text{F})$	$X - 0.5^{\circ}\text{C} (-0.9^{\circ}\text{F})$ or $Y + 0.5^{\circ}\text{C} (0.9^{\circ}\text{F})$ (zone B) continues for 10 min.
23.5°C (74.3°F) ∴ 18°C (64.4°F)		$X - 2.0^{\circ}\text{C} (-3.6^{\circ}\text{F})$	$X - 0.5^{\circ}\text{C} (-0.9^{\circ}\text{F})$ or $Y + 0.5^{\circ}\text{C} (0.9^{\circ}\text{F})$ (zone B) continues for 10 min.
17.5°C (63.5°F) ∴	18°C (64.4°F)	$X - 2.0^{\circ}\text{C} (-3.6^{\circ}\text{F})$	$X - 0.5^{\circ}\text{C} (-0.9^{\circ}\text{F}) = 17.5^{\circ}\text{C} (63.5^{\circ}\text{F})$ or $Y + 0.5^{\circ}\text{C} (0.9^{\circ}\text{F})$ (zone B) continues for 10 min.

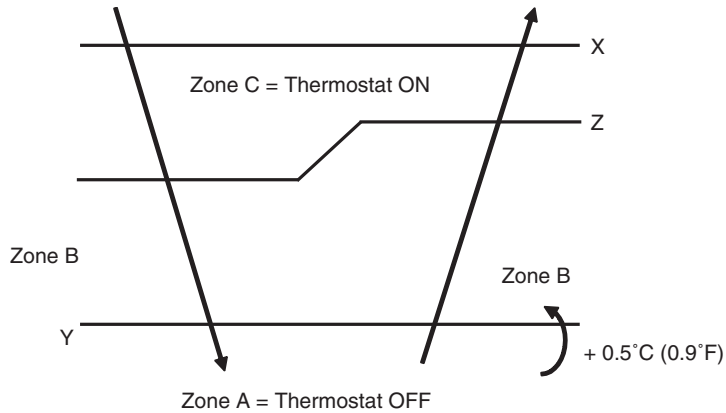

(R11587)

1.6 Automatic Operation

Outline

Automatic Cooling / Heating Function

When the AUTO mode is selected with the remote controller, the microcomputer automatically determines the operation mode as cooling or heating according to the room temperature and the set temperature at startup, and automatically operates in that mode.

The unit automatically switches the operation mode to maintain the room temperature at the set temperature.

Detail

Ts: set temperature (set by remote controller)

Tt: target temperature (determined by microcomputer)

Tr: room thermistor temperature (detected by room temperature thermistor)

C: correction value

- The set temperature (Ts) determines the target temperature (Tt).
(Ts = 18 ~ 30°C, 64.4 ~ 86°F).
- The target temperature (Tt) is calculated as;

$$Tt = Ts + C$$
 where C is the correction value.

$$C = 0^{\circ}\text{C} (0^{\circ}\text{F})$$
- Thermostat ON/OFF point and mode switching point are as follows.
 Tr means the room thermistor temperature.
 - Heating → Cooling switching point:

$$Tr \geq Tt + 3.0^{\circ}\text{C} (+5.4^{\circ}\text{F})$$
 - Cooling → Heating switching point:

$$Tr < Tt - 2.5^{\circ}\text{C} (-4.5^{\circ}\text{F})$$
 - Thermostat ON/OFF point is the same as the ON/OFF point of cooling or heating operation.
- During initial operation
 - $Tr \geq Ts$: Cooling operation
 - $Tr < Ts$: Heating operation

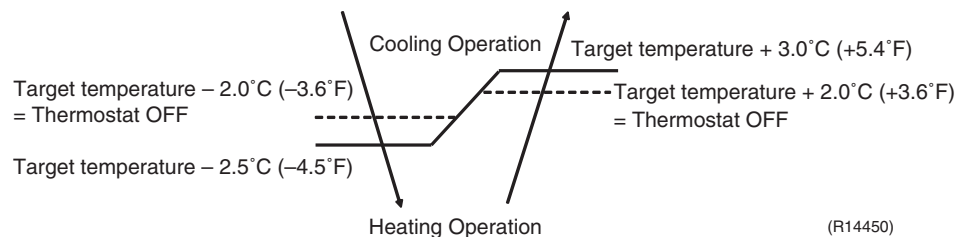

Ex: When the target temperature is 25°C (77°F)

Cooling → 23°C (73.4°F): Thermostat OFF → 22°C (71.6°F): Switch to heating

Heating → 27°C (80.6°F): Thermostat OFF → 28°C (82.4°F): Switch to cooling

1.7 Thermostat Control

Thermostat control is based on the difference between the room thermistor temperature and the target temperature.

Thermostat OFF Condition

- ◆ The temperature difference is in zone A.

Thermostat ON Condition

- ◆ The temperature difference is above zone C after being in zone A.
- ◆ The system resumes from defrost control in any zones except A.
- ◆ The operation turns on in any zones except A.
- ◆ The monitoring time has passed while the temperature difference is in zone B.
(Cooling / Dry: 10 minutes, Heating: 10 seconds)

<Cooling / Dry>

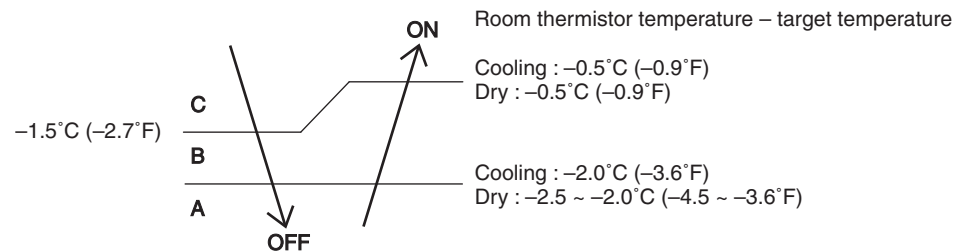

<Heating>

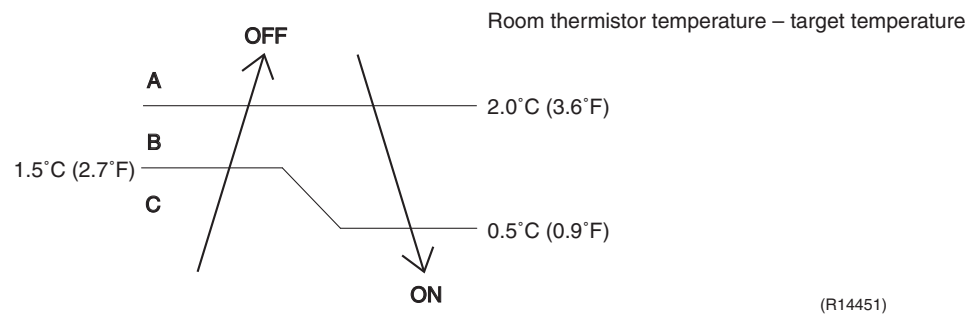

Refer to “Temperature Control” on page 13 for detail.

1.8 NIGHT SET Mode

Outline When the OFF timer is set, the NIGHT SET Mode is automatically activated. The NIGHT SET Mode keeps the airflow rate setting.

Detail The NIGHT SET Mode continues operation at the target temperature for the first hour, then automatically raises the target temperature slightly in the case of cooling, or lowers it slightly in the case of heating. This prevents excessive cooling in summer and excessive heating in winter to ensure comfortable sleeping conditions, and also conserves electricity.

<Cooling>

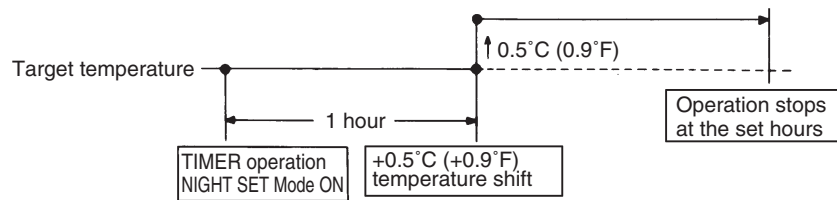

<Heating>

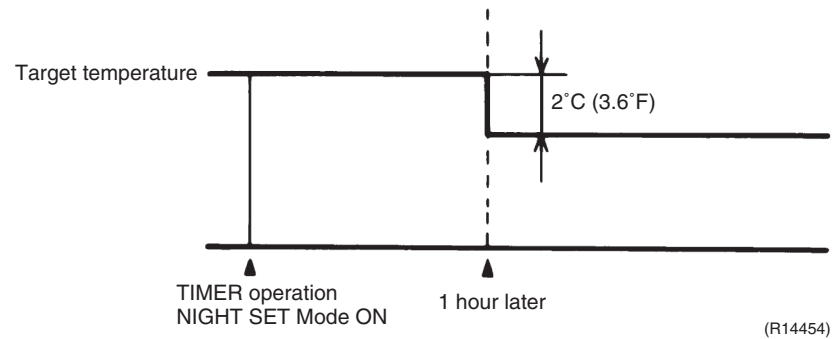

1.9 ECONO Operation

Outline

The "ECONO operation" reduces the maximum operating current and the power consumption. This operation is particularly convenient for energy-saving users. It is also a major bonus for those whose breaker capacities do not allow the use of multiple electrical devices and air conditioners. It is easily activated from the wireless remote controller by pushing the ECONO button.

- When this function is activated, the maximum capacity also decreases.
- The remote controller can send the ECONO command when the unit is in COOL, HEAT, DRY, or AUTO operation. This function can only be set when the unit is running. Pressing the ON/OFF button on the remote controller cancels the function.
- This function and POWERFUL operation cannot be used at the same time. The latest command has the priority.

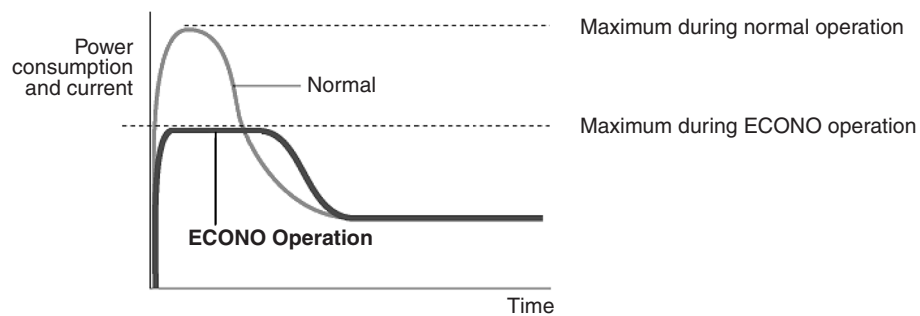

(R9288)

Detail

- ECONO mode can be activated while the unit is running. The remote controller can send the ECONO command when the unit is in COOL, HEAT, DRY, or AUTO operation.
- When the ECONO command is valid, the power consumption is reduced.

Upper limit of power consumption

60 Hz, 208 V / 230 V

	Cooling		Heating	
	Normal	ECONO	Normal	ECONO
30 class	2800	1500	3900	1500
36 class	4000 / 4300	2500	3800 / 4200	2500

(unit: W)

1.10 INTELLIGENT EYE Operation

Outline

This function detects movement in the room by a human motion sensor (INTELLIGENT EYE), reducing capacity when the room is empty in order to save electricity.

Detail

1. Detection method by INTELLIGENT EYE

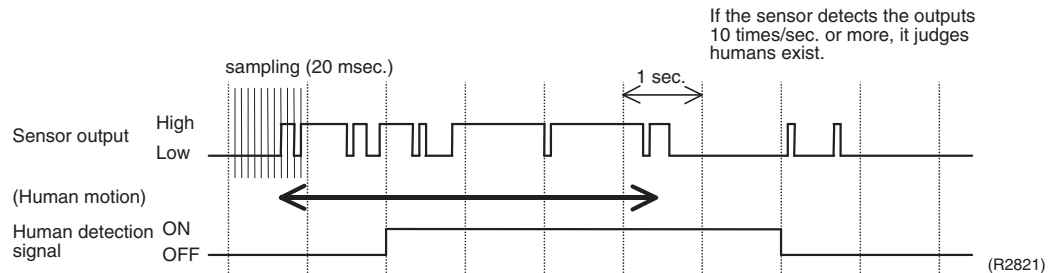

- This sensor detects human motion by receiving infrared rays and displays the pulse wave output.
- The microcomputer in the indoor unit carries out a sampling every 20 msec. and if it detects 10 cycles of the wave in one second in total (corresponding to $20 \text{ msec.} \times 10 = 200 \text{ msec.}$), it determines there is movement in the room as the motion signal is ON.

2. The motions (for example: in cooling)

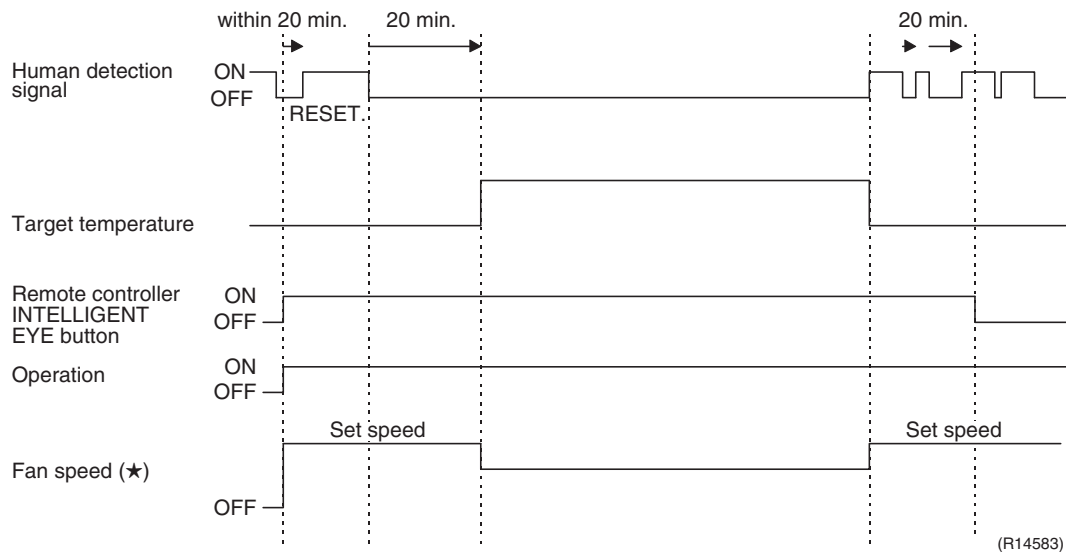

- When a microcomputer does not have a signal from the sensor in 20 minutes, it detects no presence is in the room and operates the unit at a temperature shifted from the target temperature. (Cooling / Dry: 2°C (3.6°F) higher, Heating: 2°C (3.6°F) lower, Auto: according to the operation mode at that time.)

★ In case of FAN mode, the fan speed reduces by 60 rpm.

Others

- For dry operation, you cannot set the temperature with a remote controller, but internally the target temperature is shifted by 2°C (3.6°F).

1.11 Inverter POWERFUL Operation

Outline

To optimize the cooling and heating capacity, operate the air conditioner by increasing the indoor fan rotating speed and the compressor frequency.

Detail

When the POWERFUL button is pressed, the fan speed and target temperature are converted to the following states for 20 minutes.

Operation mode	Fan speed	Target temperature
COOL	H tap + A rpm	18°C (64.4°F)
DRY	Dry rotating speed + A rpm	Lowered by 2.5°C (4.5°F)
HEAT	H tap + A rpm	31.5°C (88.7°F)
FAN	H tap + A rpm	—
AUTO	Same as cooling / heating in POWERFUL operation	The target temperature is kept unchanged.

A = 50 rpm

Ex.): POWERFUL operation in cooling mode.

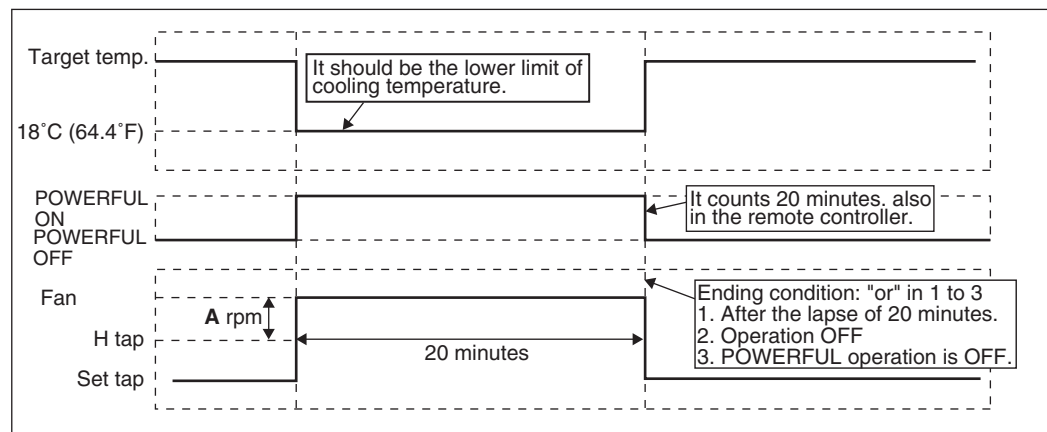

(R13571)

1.12 Other Functions

1.12.1 Hot-Start Function

In order to prevent the cold air blast that normally comes when heating operation is started, the temperature of the indoor heat exchanger is detected, and either the airflow is stopped or lowers to ensure comfortable heating of the room.

*The cold air blast is also prevented using a similar control when the defrosting operation is started or when the thermostat is turned ON.

1.12.2 Signal Receiving Sign

When the indoor unit receives a signal from the remote controller, the unit emits a signal receiving sound.

1.12.3 Indoor Unit ON/OFF Button

An ON/OFF button is provided on the display of the unit.

- Press this button once to start operation. Press once again to stop it.
- This button is useful when the remote controller is missing or the battery is dead.
- The operation mode refers to the following table.

	Mode	Temperature setting	Airflow rate
Cooling Only	COOL	22°C (71.6°F)	Automatic
Heat Pump	AUTO	25°C (77°F)	Automatic

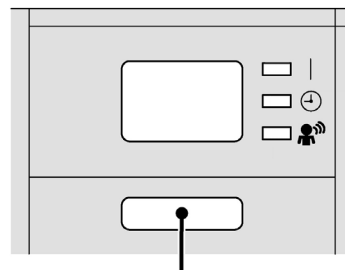

ON/OFF button (R13555)

<Forced cooling operation>

Forced cooling operation can be started by pressing the ON/OFF button for 5 to 9 seconds while the unit is not operating.

Refer to page 183 for detail.



Note: When the ON/OFF button is pressed for 10 seconds or more, the forced cooling operation is stopped.

1.12.4 Titanium Apatite Photocatalytic Air-Purifying Filter

This filter combines the Air-Purifying Filter and Titanium Apatite Photocatalytic Deodorizing Filter as a single highly effective filter. The filter traps microscopic particles, decomposes odors and even deactivates bacteria and viruses. It lasts for 3 years without replacement if washed about once every 6 months.

1.12.5 Auto-restart Function

If a power failure (including one for just a moment) occurs during the operation, the operation restarts automatically when the power is restored in the same condition as before the power failure.



Note: It takes 3 minutes to restart the operation because the 3-minute standby function is activated.

1.12.6 WEEKLY TIMER Operation

Up to 4 timer settings can be saved for each day of the week (up to 28 settings in total).

ON / OFF, Temperature and Time can be set.



Refer to page 57 for detail.

2. Function of Thermistor

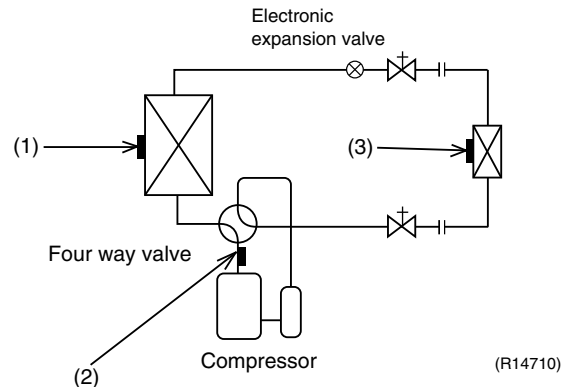

(1) Outdoor Heat Exchanger Thermistor

1. The outdoor heat exchanger thermistor is used for controlling target discharge pipe temperature. The system sets the target discharge pipe temperature according to the outdoor and indoor heat exchanger temperature, and controls the electronic expansion valve opening so that the target discharge pipe temperature can be obtained.
2. In cooling operation, the outdoor heat exchanger thermistor is used for detecting disconnection of the discharge pipe thermistor. When the discharge pipe temperature becomes lower than the outdoor heat exchanger temperature, the discharge pipe thermistor is judged as disconnected.
3. In cooling operation, the outdoor heat exchanger thermistor is used for high pressure protection.

(2) Discharge Pipe Thermistor

1. The discharge pipe thermistor is used for controlling the discharge pipe temperature. If the discharge pipe temperature (used in place of the inner temperature of the compressor) rises abnormally, the operating frequency becomes lower or the operation halts.
2. The discharge pipe thermistor is used for detecting disconnection of the discharge pipe thermistor.

(3) Indoor Heat Exchanger Thermistor

1. The indoor heat exchanger thermistor is used for controlling target discharge pipe temperature. The system sets the target discharge pipe temperature according to the outdoor and indoor heat exchanger temperature, and controls the electronic expansion valve opening so that the target discharge pipe temperature can be obtained.
2. In cooling operation, the indoor heat exchanger thermistor is used for freeze-up protection control. If the indoor heat exchanger temperature drops abnormally, the operating frequency lowers, and the operation halts.
3. In heating operation, the indoor heat exchanger thermistor is used for detecting disconnection of the discharge pipe thermistor. When the discharge pipe temperature becomes lower than the indoor heat exchanger temperature, the discharge pipe thermistor is judged as disconnected.

3. Control Specification

3.1 Mode Hierarchy

Outline

There are two modes: normal operation mode and forced operation mode for installation and providing servicing.

Detail

For Cooling Only Model

There are following modes.

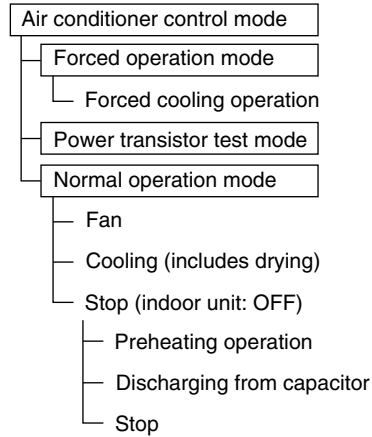

(R14428)

For Heat Pump Model

There are following modes.

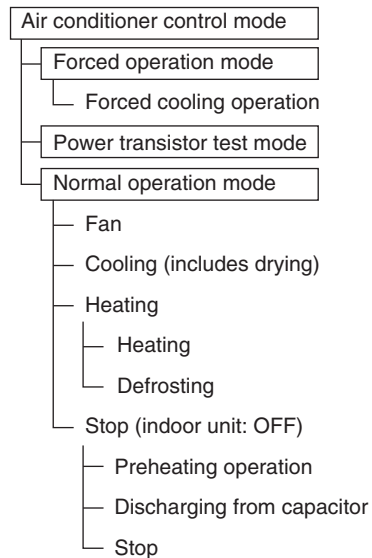

(R14248)



Note: Unless specified otherwise, an indoor dry operation command is regarded as cooling operation.

3.2 Frequency Control

Outline

Frequency is determined according to the difference between the room thermistor temperature and the target temperature.

The function is explained as follows.

1. How to determine frequency
2. Frequency command from the indoor unit (Difference between the room thermistor temperature and the target temperature)
3. Frequency initial setting
4. PI control

When the shift of the frequency is less than zero ($\Delta F < 0$) by PI control, the target frequency is used as the command frequency.

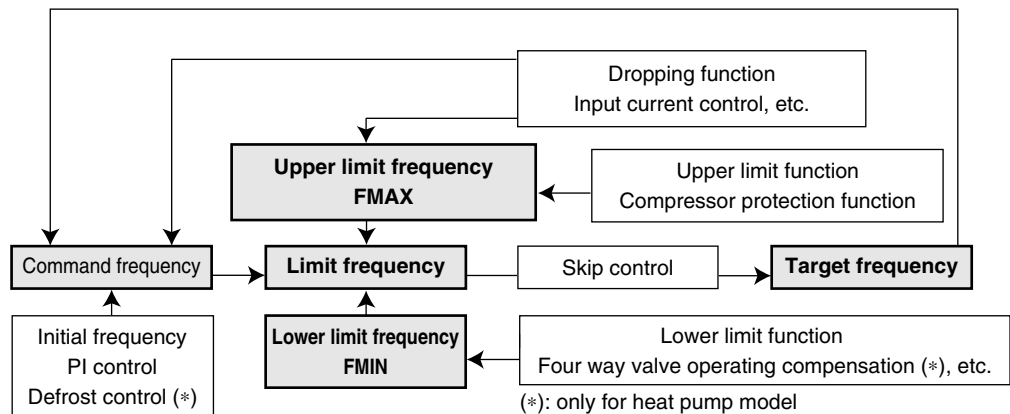

(R14717)

Detail

How to Determine Frequency

The compressor's frequency is determined by taking the following steps.

For Cooling Only Model

1. Determine command frequency

- ◆ Command frequency is determined in the following order of priority.
 1. Forced cooling
 2. Indoor frequency command

2. Determine upper limit frequency

- ◆ The minimum value is set as an upper limit frequency among the frequency upper limits of the following functions:
Compressor protection, input current, discharge pipe temperature, freeze-up protection.

3. Determine lower limit frequency

- ◆ The maximum value is set as a lower limit frequency among the frequency lower limits of the following function:
Pressure difference stabilization.

4. Determine prohibited frequency

- ◆ There is a certain prohibited frequency such as a power supply frequency.

For Heat Pump Model

1. Determine command frequency

- ◆ Command frequency is determined in the following order of priority.
 1. Limiting defrost control time
 2. Forced cooling
 3. Indoor frequency command

2. Determine upper limit frequency

- ♦ The minimum value is set as an upper limit frequency among the frequency upper limits of the following functions:
Compressor protection, input current, discharge pipe temperature, heating peak-cut, freeze-up protection, defrost.

3. Determine lower limit frequency

- ♦ The maximum value is set as a lower limit frequency among the frequency lower limits of the following functions:
Four way valve operation compensation, draft prevention, pressure difference upkeep.

4. Determine prohibited frequency

- ♦ There is a certain prohibited frequency such as a power supply frequency.

Indoor Frequency Command (ΔD signal)

The difference between the room thermistor temperature and the target temperature is taken as the " ΔD signal" and is used for frequency command.

Temperature difference	ΔD signal	Temperature difference	ΔD signal	Temperature difference	ΔD signal	Temperature difference	ΔD signal
-2.0°C (-3.6°F)	*Th OFF	0°C (0°F)	4	2.0°C (3.6°F)	8	4.0°C (7.2°F)	C
-1.5°C (-2.7°F)	1	0.5°C (0.9°F)	5	2.5°C (4.5°F)	9	4.5°C (8.1°F)	D
-1.0°C (-1.8°F)	2	1.0°C (1.8°F)	6	3.0°C (5.4°F)	A	5.0°C (9°F)	E
-0.5°C (-0.9°F)	3	1.5°C (2.7°F)	7	3.5°C (6.3°F)	B	5.5°C (9.9°F)	F

*Th OFF = Thermostat OFF

Frequency Initial Setting**<Outline>**

When starting the compressor, the frequency is initialized according to the ΔD value and the Q value of the indoor unit.

Q value: Indoor unit output determined from indoor unit volume, airflow rate and other factors.

PI Control (Determine Frequency Up / Down by ΔD Signal)**1. P control**

The ΔD value is calculated in each sampling time (20 seconds), and the frequency is adjusted according to its difference from the frequency previously calculated.

2. I control

If the operating frequency does not change for more than a certain fixed time, the frequency is adjusted according to the ΔD value.

When the ΔD value is low, the frequency is lowered.

When the ΔD value is high, the frequency is increased.

3. Frequency management when other controls are functioning

- ♦ When frequency is dropping;
Frequency management is carried out only when the frequency drops.
- ♦ For limiting lower limit
Frequency management is carried out only when the frequency rises.

4. Upper and lower limit of frequency by PI control

The frequency upper and lower limits are set according to the command on indoor unit.

When the indoor or outdoor unit quiet operation command comes from the indoor unit, the upper limit frequency is lower than the usual setting.

3.3 Controls at Mode Changing / Start-up

3.3.1 Preheating Operation

Outline The inverter operation in open phase starts with the conditions of the preheating command from the indoor unit, the outdoor temperature, and the discharge pipe temperature.

Detail Outdoor temperature $\geq 10^{\circ}\text{C}$ (50°F) → Control A (preheating for normal state)
 Outdoor temperature $< 10^{\circ}\text{C}$ (50°F) → Control B (preheating of increased capacity)

Control A

- ◆ ON condition
 - Discharge pipe temperature $< 6^{\circ}\text{C}$ (42.8°F)
 - Radiation fin temperature $< 85^{\circ}\text{C}$ (185°F)
- ◆ OFF condition
 - Discharge pipe temperature $> 8^{\circ}\text{C}$ (46.4°F)
 - Radiation fin temperature $\geq 90^{\circ}\text{C}$ (194°F)

Control B

- ◆ ON condition
 - Discharge pipe temperature $< 10.5^{\circ}\text{C}$ (50.9°F)
 - Radiation fin temperature $< 85^{\circ}\text{C}$ (185°F)
- ◆ OFF condition
 - Discharge pipe temperature $> 12^{\circ}\text{C}$ (53.6°F)
 - Radiation fin temperature $\geq 90^{\circ}\text{C}$ (194°F)



Note: The power consumption of compressor during preheating operation is 35 W.

3.3.2 Four-Way Valve Switching

Outline In heating operation, current is conducted, and in cooling and defrosting, current is not conducted. In order to eliminate the switching sound when the heating is stopped, as the four-way valve coil switches from ON to OFF, and the OFF delay switch of the four-way valve is carried out after the operation stopped.

Detail **OFF delay switch of four way valve:**
 The four-way valve coil is energized for 150 seconds after the operation is stopped.

3.3.3 Four Way Valve Operation Compensation

Outline

At the beginning of the operation as the four way valve is switched, the differential pressure to activate the four way valve is acquired by having output frequency which is more than a certain fixed frequency, for a certain fixed time.

Detail

Starting Conditions

1. When starting compressor for heating
2. When the operation mode changes from heating to cooling
3. When starting compressor for defrosting
4. When starting compressor for heating after defrosting
5. When starting compressor for the first time after resetting with the power ON
6. When starting compressor after the fault of switching over cooling / heating

The lower limit of frequency keeps **A** Hz for **B** seconds with any conditions 1 through 6 above.

	Cooling	Heating
A (Hz)	83	
B (seconds)	70	

3.3.4 3-minute Standby

Turning on the compressor is prohibited for 3 minutes after turning it off.
(Except when defrosting.)

3.3.5 Compressor Protection Function

When turning the compressor from OFF to ON, the upper limit of frequency is set as follows. The Compressor Protection Function is unavailable when defrosting.

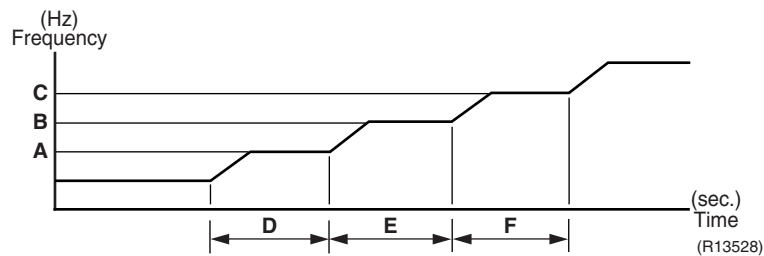

A (Hz)	46 ~ 55
B (Hz)	65
C (Hz)	80
D (seconds)	120 ~ 500
E (seconds)	100 ~ 200
F (seconds)	470

3.4 Discharge Pipe Temperature Control

Outline

The discharge pipe temperature is used as the internal temperature of the compressor. If the discharge pipe temperature rises above a certain level, the upper limit of frequency is set to keep this temperature from going up further.

Detail

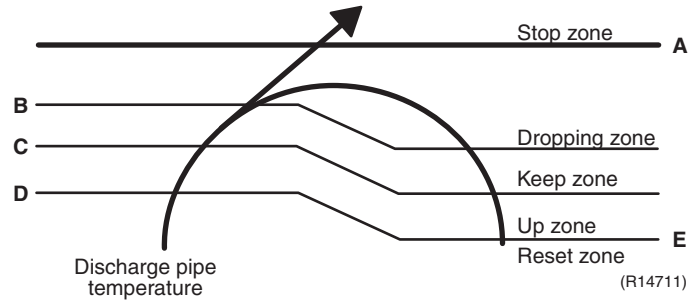

Zone	Control
Stop zone	When the temperature reaches the stop zone, the compressor stops.
Dropping zone	The upper limit of frequency decreases.
Keep zone	The upper limit of frequency is kept.
Up zone	The upper limit of frequency increases.
Reset zone	The upper limit of frequency is canceled.

A	120°C (248°F)
B	111°C (231.8°F)
C	109°C (228.2°F)
D	107°C (224.6°F)
E	107°C (224.6°F)

3.5 Input Current Control

Outline

The microcomputer calculates the input current while the compressor is running, and sets the frequency upper limit from the input current.

In case of heat pump model, this control which is the upper limit control of the frequency takes priority to the lower limit of control of four way valve operation compensation.

Detail

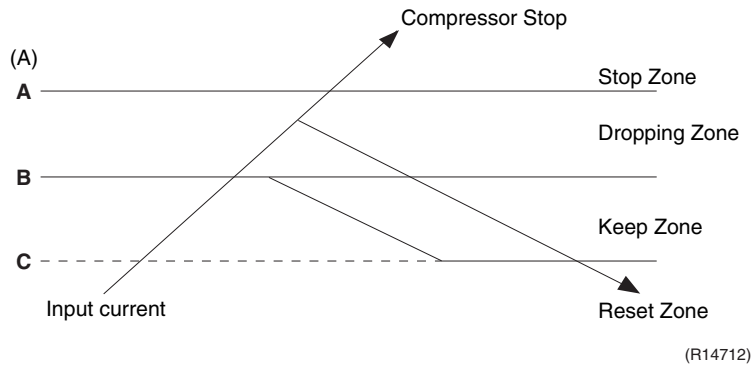

Frequency control in each zone

Stop zone

- ◆ After 2.5 seconds in this zone, the compressor is stopped.

Dropping zone

- ◆ The upper limit of the compressor frequency is defined as operation frequency – 2 Hz.
- ◆ After this, the output frequency is pulled down by 2 Hz every second until it reaches the keep zone.

Keep zone

- ◆ The present maximum frequency goes on.

Reset zone

- ◆ Limit of the frequency is canceled.

	Cooling	Heating
A (A)	20.0	
B (A)	19.0	
C (A)	18.0	

Limitation of current dropping and stop value according to the outdoor temperature

- ◆ The current drops when outdoor temperature becomes higher than a certain level (depending on the model).

3.6 Freeze-up Protection Control

Outline

During cooling operation, the signal sent from the indoor unit controls the operating frequency limitation and prevents freezing of the indoor heat exchanger. (The signal from the indoor unit is divided into zones.)

Detail

The operating frequency limitation is judged with the indoor heat exchanger temperature.

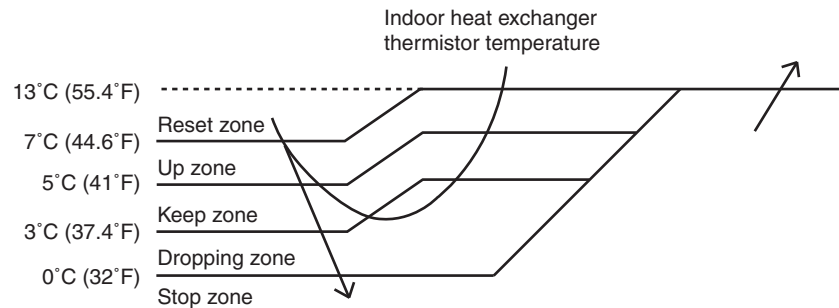

(R14456)

3.7 Heating Peak-cut Control

Outline

During heating operation, the indoor heat exchanger temperature determines the frequency upper limit to prevent abnormal high pressure.

Detail

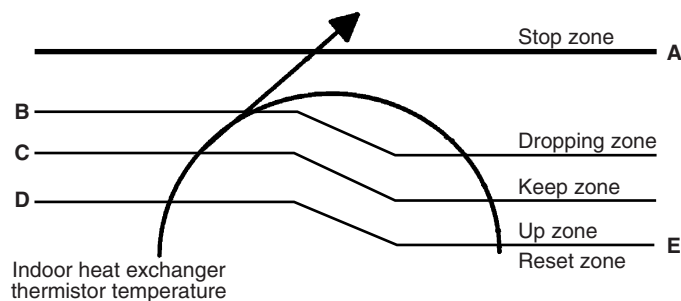

(R14713)

Zone	Control
Stop zone	When the temperature reaches the stop zone, the compressor stops.
Dropping zone	The upper limit of frequency decreases.
Keep zone	The upper limit of frequency is kept.
Up zone	The upper limit of frequency increases.
Reset zone	The upper limit of frequency is canceled.

A	65°C (149°F)
B	56°C (132.8°F)
C	55°C (131°F)
D	53°C (127.4°F)
E	51°C (123.8°F)

3.8 Outdoor Fan Control

1. Fan OFF delay when stopped

The outdoor fan is turned OFF 60 seconds after the compressor stops.

2. Fan ON control to cool down the electrical box

The outdoor fan is turned ON when the electrical box temperature is high while the compressor is OFF.

3. Fan OFF control while defrosting

The outdoor fan is turned OFF while defrosting.

4. Fan ON/OFF control when operation starts / stops

The outdoor fan is turned ON when the operation starts. The outdoor fan is turned OFF when the operation stops.

5. Fan speed while forced cooling operation

The outdoor fan is controlled as well as normal operation while the forced cooling operation.

6. Fan speed control while indoor / outdoor unit quiet operation

The rotation speed of the outdoor fan is reduced by the command of the indoor/outdoor unit quiet operation.

7. Fan speed for POWERFUL operation

The rotation speed of the outdoor fan is increased while the POWERFUL operation.

8. Fan speed control for pressure difference upkeep

The rotation speed of the outdoor fan is controlled for keeping the pressure difference while cooling with low outdoor temperature.

- ◆ When the pressure difference is low, the rotation speed of the outdoor fan is reduced.
- ◆ When the pressure difference is high, the rotation speed of the outdoor fan is controlled as well as normal operation.

3.9 Liquid Compression Protection Function

Outline

In order to ensure the dependability of the compressor, the compressor is stopped according to the outdoor temperature and temperature of the outdoor heat exchanger.

Detail

- Operation stops depending on the outdoor temperature

Compressor turns off under the conditions that the system is in cooling operation and outdoor temperature is below -12°C (10.4°F).

3.10 Defrost Control

Outline

Defrosting is carried out by the cooling cycle (reverse cycle). The defrosting time or outdoor heat exchanger temperature must be more than a certain value to finish.

Detail

Conditions for Starting Defrost

- The starting conditions are determined with the outdoor temperature and the outdoor heat exchanger temperature.
- The system is in heating operation.
- The compressor operates for 6 minutes.
- More than **A** minutes of accumulated time pass since the start of the operation, or ending the previous defrosting.

Conditions for Canceling Defrost

The judgment is made with outdoor heat exchanger temperature. (4 ~ 18°C, 39.2 ~ 64.4°F)

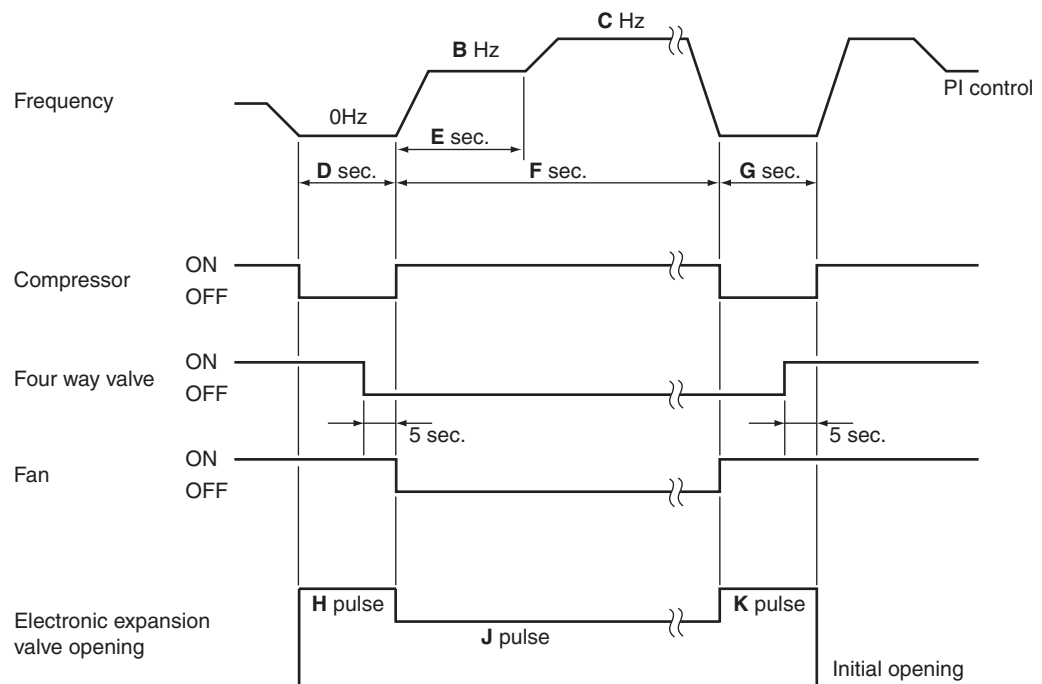

(R13533)

A (minutes)	38
B (Hz)	39
C (Hz)	62
D (seconds)	60
E (seconds)	120
F (seconds)	650
G (seconds)	60
H (pulse)	450
J (pulse)	350
K (pulse)	400

3.11 Electronic Expansion Valve Control

Outline

The following items are included in the electronic expansion valve control.

Electronic expansion valve is fully closed

1. Electronic expansion valve is fully closed when turning on the power.
2. Pressure equalizing control

Open Control

1. Electronic expansion valve control when starting operation
2. Electronic expansion valve control when the frequency changes
3. Electronic expansion valve control for defrosting
4. Electronic expansion valve control when the discharge pipe temperature is abnormally high
5. Electronic expansion valve control when the discharge pipe thermistor is disconnected

Feedback Control

1. Target discharge pipe temperature control

Detail

The followings are the examples of control which function in each mode by the electronic expansion valve control.

	When the power turns on or when the compressor stops	When the operation starts	When the frequency changes under starting control	During target discharge pipe temperature control	When the frequency changes under target discharge pipe temperature control	When the disconnection of the discharge pipe thermistor is ascertained	When the frequency changes under the control for disconnection of the discharge pipe thermistor	Under defrost control
● : function - : not function								
Cooling								
Starting control	-	●	-	-	-	-	-	-
Control when the frequency changes	-	-	●	-	●	-	-	-
Target discharge pipe temperature control	-	-	-	●	-	-	-	-
Control for disconnection of the discharge pipe thermistor	-	-	-	-	-	●	●	-
High discharge pipe temperature control	-	●	●	●	●	-	-	-
Pressure equalizing control	●	-	-	-	-	-	-	-
Opening limit control	-	●	●	●	●	●	●	-
Heating								
Starting control	-	●	-	-	-	-	-	-
Control when the frequency changes	-	-	●	-	●	-	-	-
Target discharge pipe temperature control	-	-	-	●	-	-	-	-
Control for disconnection of the discharge pipe thermistor	-	-	-	-	-	●	●	-
High discharge pipe temperature control	-	●	●	●	●	-	-	-
Defrost control	-	-	-	-	-	-	-	●
Pressure equalizing control	●	-	-	-	-	-	-	-
Opening limit control	-	●	●	●	●	●	●	-

(R14458)

3.11.1 Fully Closing with Power ON

The electronic expansion valve is initialized when turning on the power. The opening position is set and the pressure equalization is developed.

3.11.2 Pressure Equalizing Control

When the compressor is stopped, the pressure equalizing control is activated. The electronic expansion valve opens, and develops the pressure equalization.

3.11.3 Opening Limit Control

Outline

A maximum and minimum opening of the electronic expansion valve are limited.

Detail

Maximum opening (pulse)	480
Minimum opening (pulse)	10

The electronic expansion valve is fully closed when cooling operation stops, and is opened at fixed degree during defrosting.

3.11.4 Starting Operation Control

The electronic expansion valve opening is controlled when the operation starts, and prevents superheating or liquid compression.

3.11.5 Control when the frequency changes

When the target discharge pipe temperature control is active, if the target frequency is changed for a specified value in a certain time period, the target discharge pipe temperature control is canceled and the target opening of the electronic expansion valve is changed according to the shift.

3.11.6 High Discharge Pipe Temperature Control

When the compressor is operating, if the discharge pipe temperature exceeds a certain value, the electronic expansion valve opens and the refrigerant runs to the low pressure side. This procedure lowers the discharge pipe temperature.

3.11.7 Control for Disconnection of the Discharge Pipe Thermistor

Outline

The disconnection of the discharge pipe thermistor is detected by comparing the discharge pipe temperature with the condensation temperature. If the discharge pipe thermistor is disconnected, the electronic expansion valve opens according to the outdoor temperature and the operation frequency, and operates for a specified time, and then stops.

After 3 minutes of waiting, the operation restarts and checks if the discharge pipe thermistor is disconnected. If the discharge pipe thermistor is disconnected, the system stops after operating for a specified time.

If the disconnection is detected repeatedly, then the system is shut down. When the compressor runs for 60 minutes without any error, the error counter is reset.

Detail

When the starting control (30 seconds) finishes, the detection timer for disconnection of the discharge pipe thermistor (630 seconds) starts. When the timer is over, the following adjustment is made.

1. When the operation mode is cooling
When the following condition is fulfilled, the discharge pipe thermistor disconnection is ascertained.
Discharge pipe temperature + 6°C (+ 10.8°F) < outdoor heat exchanger temperature
2. When the operation mode is heating
When the following condition is fulfilled, the discharge pipe thermistor disconnection is ascertained.
Discharge pipe temperature + 6°C (+ 10.8°F) < indoor heat exchanger temperature

Adjustment when the thermistor is disconnected

When the disconnection is ascertained, the compressor continues operation for 9 minutes and then stops.

When the compressor stops repeatedly, the system is shut down.

3.11.8 Target Discharge Pipe Temperature Control

The target discharge pipe temperature is obtained from the indoor and outdoor heat exchanger temperature, and the electronic expansion valve opening is adjusted so that the actual discharge pipe temperature becomes close to the target discharge pipe temperature. (Indirect SH (superheating) control using the discharge pipe temperature)

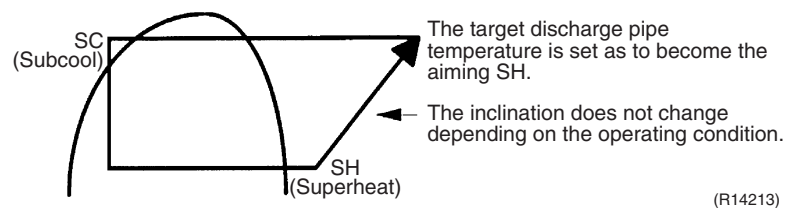

The electronic expansion valve opening and the target discharge pipe temperature are adjusted every 20 seconds. The target discharge pipe temperature is controlled by indoor heat exchanger temperature and outdoor heat exchanger temperature. The opening degree of the electronic expansion valve is controlled by followings.

- ◆ Target discharge pipe temperature
- ◆ Actual discharge pipe temperature
- ◆ Previous discharge pipe temperature

3.12 Malfunctions

3.12.1 Sensor Malfunction Detection

Sensor malfunction may occur in the thermistor.

Relating to Thermistor Malfunction

1. Outdoor heat exchanger thermistor
2. Discharge pipe thermistor
3. Radiation fin thermistor
4. Outdoor temperature thermistor

3.12.2 Detection of Overcurrent and Overload

Outline

An excessive output current is detected and, the OL temperature is observed to protect the compressor.

Detail

- If the OL (compressor head) temperature exceeds 120 ~ 130°C (248 ~ 266°F), the system shuts down the compressor.
- If the inverter current exceeds 20 A, the system shuts down the compressor.
The upper limit of the current decreases when the outdoor temperature exceeds a certain level.

3.12.3 Refrigerant Shortage Control

Outline

I: Detecting by power consumption

If the power consumption is below the specified value and the frequency is higher than the specified frequency, it is regarded as refrigerant shortage.

The power consumption is low comparing with that in the normal operation when refrigerant is insufficient, and refrigerant shortage is detected by checking a power consumption.

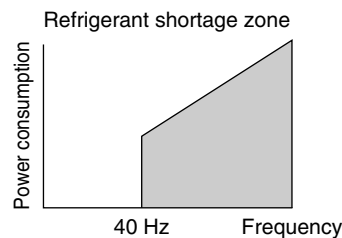

(R14459)

II: Detecting by discharge pipe temperature

If the discharge pipe temperature is higher than the target discharge pipe temperature, and the electronic expansion valve is fully open for more than the specified time, it is regarded as refrigerant shortage.

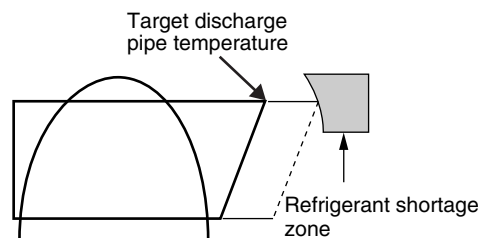

(R1391)



Refer to page 105 for detail.

Part 5

Operation Manual

1. System Configuration	42
2. Operation Manual.....	43
2.1 Remote Controller	43
2.2 AUTO · DRY · COOL · HEAT · FAN Operation	45
2.3 Adjusting the Airflow Direction.....	47
2.4 COMFORT AIRFLOW Operation	49
2.5 INTELLIGENT EYE Operation	50
2.6 POWERFUL Operation	52
2.7 OUTDOOR UNIT QUIET Operation.....	53
2.8 ECONO Operation	54
2.9 TIMER Operation	55
2.10 WEEKLY TIMER Operation	57

1. System Configuration

After installation and test operation of the room air conditioner are completed, the air conditioner should be handled and operated as described in the following pages. Every user should be informed on the correct method of operation and how to check if it can cool (or heat) well, and how to use it efficiently.

Providing instructions to the user can reduce requests for servicing by 80%. However proficient the installation and operating functions of the air conditioning system are, the customer may fault either the room air conditioner or its installation work when it is actually due to improper handling. The installation work and the handing-over of the unit can only be considered completed when its handling has been fully explained to the user without using technical terms, and while imparting full knowledge of the equipment.

2. Operation Manual

2.1 Remote Controller

Name of Parts

Remote Controller: ARC452A21

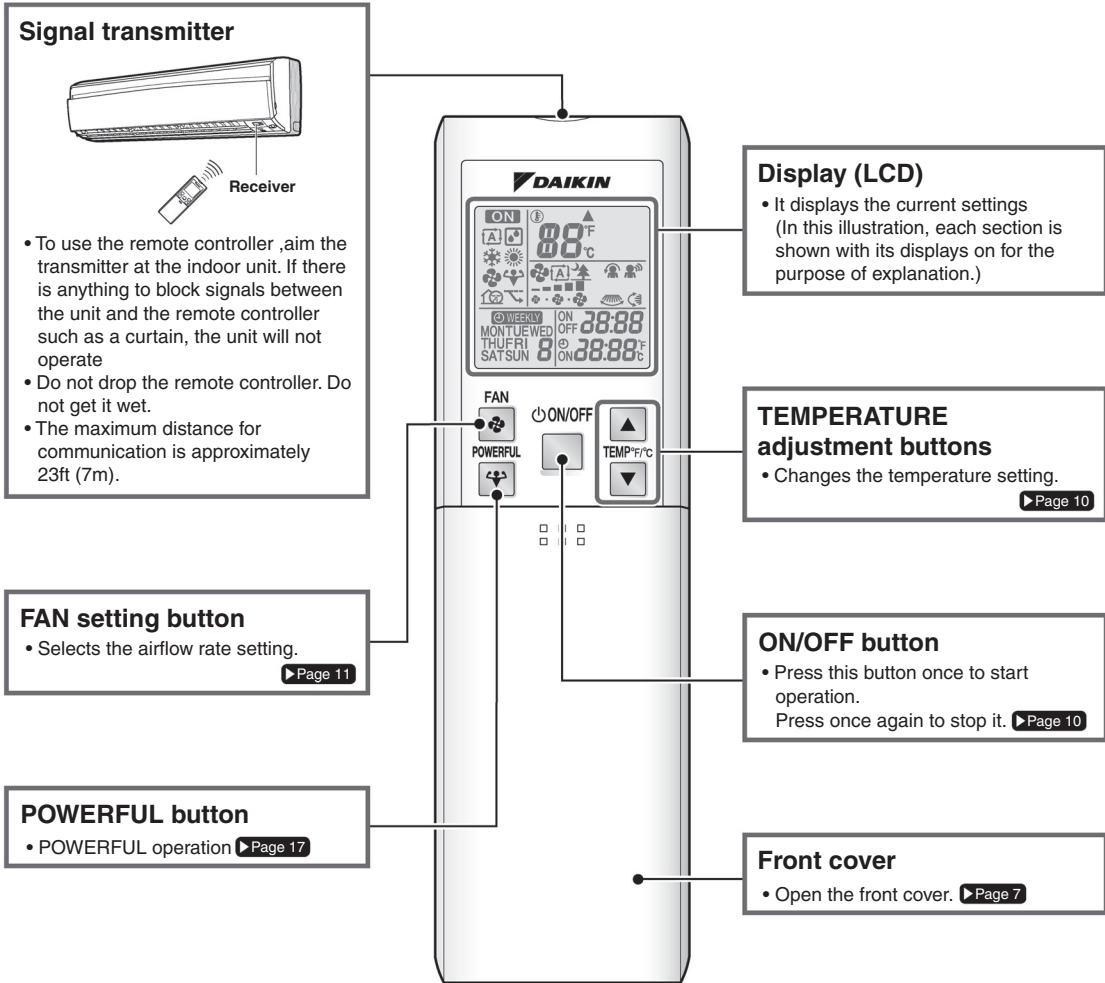

Open the front cover

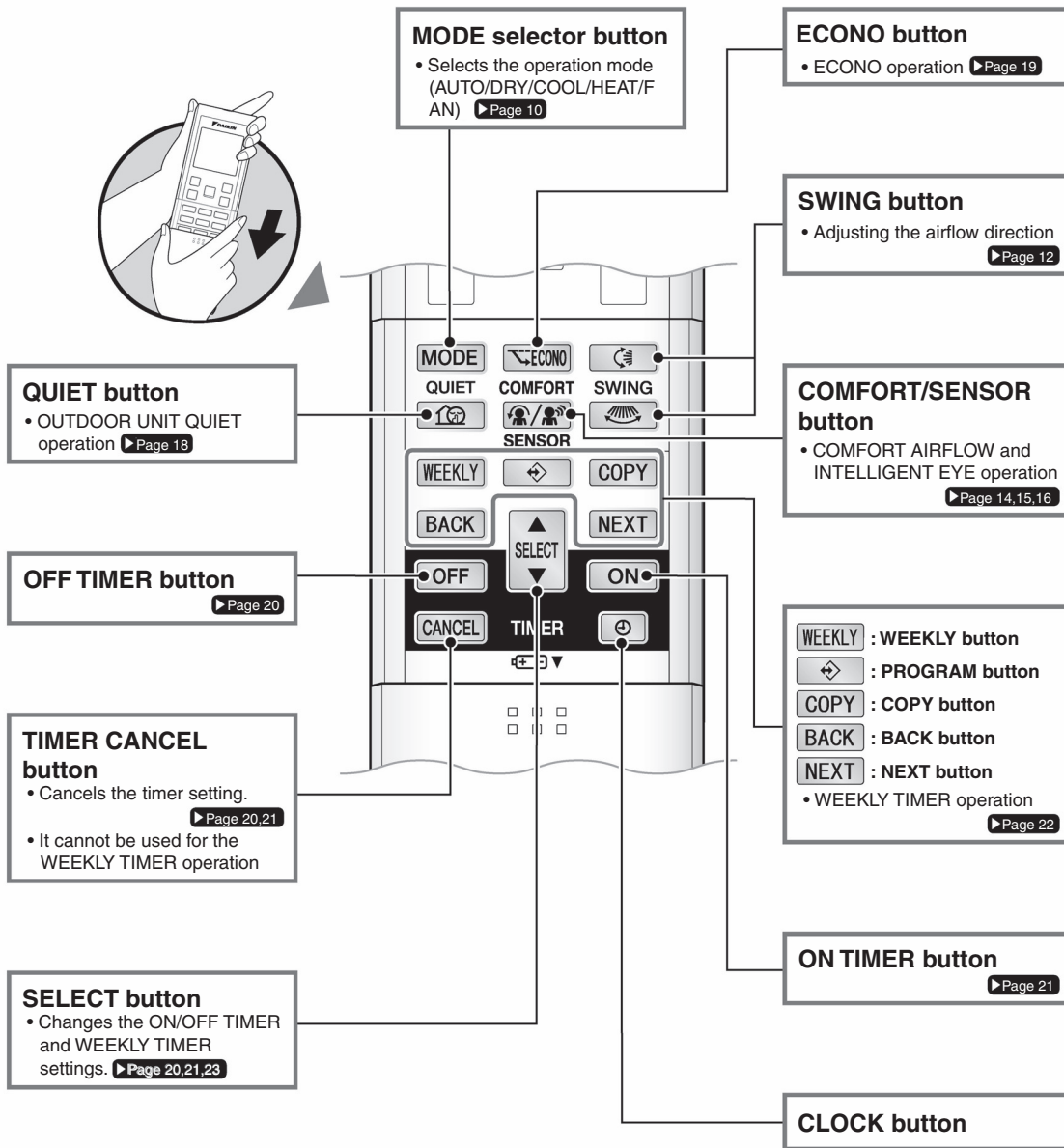
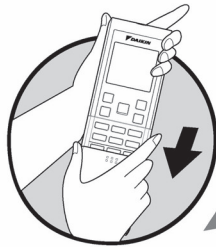

2.2 AUTO · DRY · COOL · HEAT · FAN Operation

AUTO · DRY · COOL · HEAT · FAN Operation

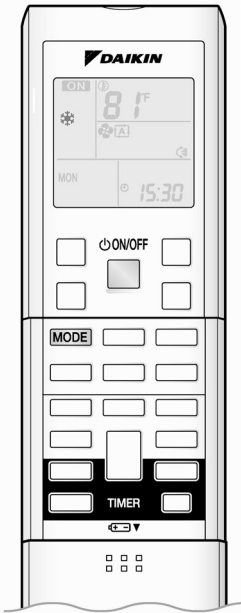

The air conditioner operates with the operation mode of your choice. From the next time on, the air conditioner will operate with the same operation mode.

■ To start operation

1. Press **MODE** and select a operation mode.

- Each pressing of the button advances the mode setting in sequence.

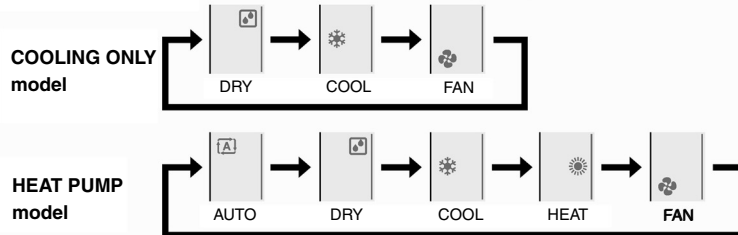

2. Press **ON/OFF**.

- "ON" is displayed on the LCD.
- The OPERATION lamp lights up.

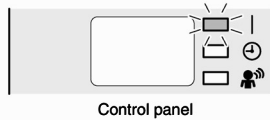

■ To stop operation

Press **ON/OFF** again

- "ON" is no longer displayed on the LCD.
- The OPERATION lamp goes off.

■ To change the temperature setting

Press **TEMP^{F/°C}** or **TEMP^{F/°C}** .



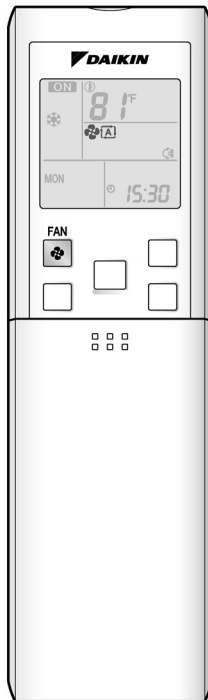

- The displayed items on the LCD will change whenever either one of the buttons is pressed.

DRY or FAN mode	COOL mode	HEAT mode	AUTO mode
The temperature setting is not variable	64-90°F (18-32°C)	50-86°F (10-30°C)	64-86°F (18-30°C)
	Press to raise the temperature and press to lower the temperature.		



■ To change the airflow rate setting

Press .

DRY mode	AUTO or COOL or HEAT or FAN mode
The airflow rate setting is not variable.	Five levels of airflow rate setting from "  to "  plus "  and "  are available. 

- Indoor unit quiet operation.
When the airflow is set to "", the noise from the indoor unit will become quieter. Use this when making the noise quieter. The unit might lose capacity when the airflow rate is set to a weak level.
- Each pressing of the button advances the airflow rate setting in sequence.

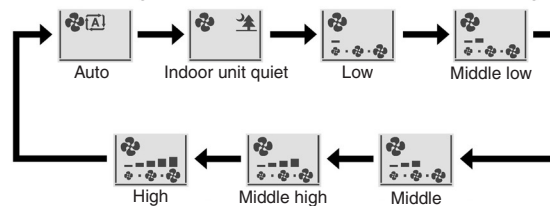

NOTE

■ Note on HEAT operation

- Since this air conditioner heats the room by taking heat from outdoor air to indoors, the heating capacity becomes smaller in lower outdoor temperatures. If the heating effect is insufficient, it is recommended to use another heating appliance in combination with the air conditioner.
- The heat pump system heats the room by circulating hot air around all parts of the room. After the start of heating operation, it takes some time before the room gets warmer.
- In heating operation, frost may occur on the outdoor unit and lower the heating capacity. In that case, the system switches into defrosting operation to take away the frost.
- During defrosting operation, hot air does not flow out of indoor unit.

■ Note on COOL operation

- This air conditioner cools the room by releasing the heat in the room outside. Therefore, the cooling performance of the air conditioner may be degraded if the outdoor temperature is high.

■ Note on DRY operation

- The computer chip works to rid the room of humidity while maintaining the temperature as much as possible. It automatically controls temperature and airflow rate, so manual adjustment of these functions is unavailable.

■ Note on AUTO operation

- In AUTO operation, the system selects an appropriate operation mode (COOL or HEAT) based on the room and outside temperatures and starts the operation.
- The system automatically reselects setting at a regular interval to bring the room temperature to user-setting level.

■ Note on FAN operation

- This mode is valid for fan only.

■ Note on airflow rate setting

- At smaller airflow rates, the cooling (heating) effect is also smaller.

2.3 Adjusting the Airflow Direction

Adjusting the Airflow Direction

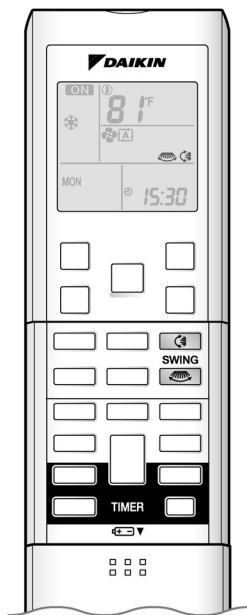

You can adjust the airflow direction to increase your comfort.

Adjusting the upper and lower airflow direction

■ To adjust the louvers (horizontal blades)

1. Press .

- "  " is displayed on the LCD and the louvers will begin to swing.

2. When the louvers have reached the desired position, press  once more.

- The louvers will stop moving.
- "  " is no longer displayed on the LCD.

Adjusting the right and left airflow direction

■ To adjust the fins (vertical blades)

3. Press .



- "  " is displayed on the LCD.

4. When the fins have reached the desired position, press the  once more.

- The fins will stop moving.
- "  " is no longer displayed on the LCD.

Adjusting the 3-D airflow direction

■ To start 3-D airflow

1. 3. Press the  and the  :
the "  " and "  " display will light up and the louvers and fins will move in turn.

■ To cancel 3-D airflow

2. 4. Press either the  or the .

■ COMFORT AIRFLOW operation

- Check COMFORT AIRFLOW operation in the section of "COMFORT AIRFLOW Operation" and "INTELLIGENT EYE Operation". [▶ Page 14,15](#)

NOTE

■ Notes on louvers and fins angles

- When "SWING button" is selected, the louvers swinging range depends on the operation. (See the figure.)

Three-dimensional (3-D) airflow

- Using three-dimensional airflow circulates cold air, which tends to be collected at the bottom of the room, and hot air, which tends to collect near the ceiling, throughout the room, preventing areas of cold and hot developing.

■ ATTENTION

- Always use a remote controller to adjust the angles of the louvers and fins. If you attempt to move it forcibly with hand when it is swinging, the mechanism may be broken.
- Always use a remote controller to adjust the fins angles. In side the air outlet, a fan is rotating at a high speed.

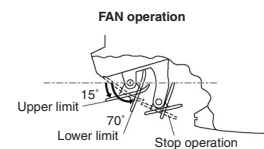
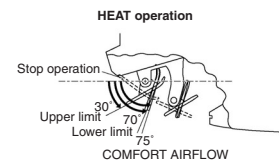
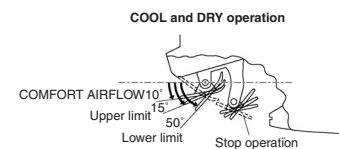

2.4 COMFORT AIRFLOW Operation

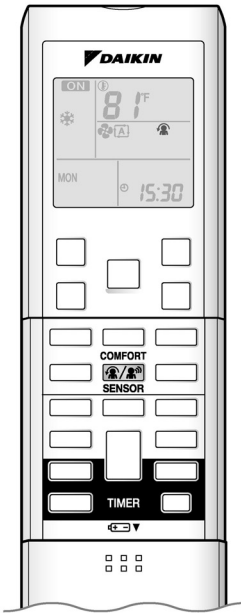

COMFORT AIRFLOW Operation



The flow of air will be in the upward direction while in COOL operation and in the downward direction while in HEAT operation, which will provide a comfortable wind that will not come in direct contact with people.

■ To start COMFORT AIRFLOW operation

1. Press and select "" on the LCD.

- Each time the  is pressed a different setting option is displayed on the LCD.
- By selecting "" from the following icons, the air conditioner will be in COMFORT AIRFLOW operation combined with INTELLIGENT EYE operation. [▶Page 16](#)



■ To cancel COMFORT AIRFLOW operation

2. Press .

- Press the button to select "Blank".

NOTE

■ Notes on COMFORT AIRFLOW operation

- The louvers position will change, preventing air from blowing directly on the occupants of the room.
- POWERFUL operation and COMFORT AIRFLOW operation cannot be used at the same time.
- The volume of air will be set to AUTO. If the upward and downward airflow direction is selected, the COMFORT AIRFLOW function will be canceled.
- Priority is given to the function of whichever button is pressed last.
- The COMFORT AIRFLOW function makes the following airflow direction adjustments.
The louvers will move upward while cooling so that the airflow will be directed upward.
The louvers will move downward while heating so that the airflow will be directed downward.

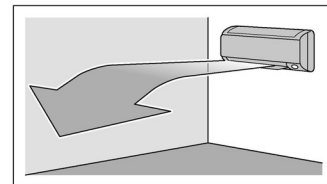

COOL operation

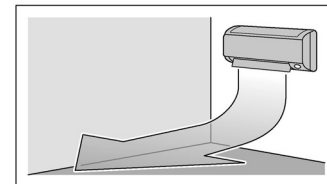

HEAT operation

2.5 INTELLIGENT EYE Operation

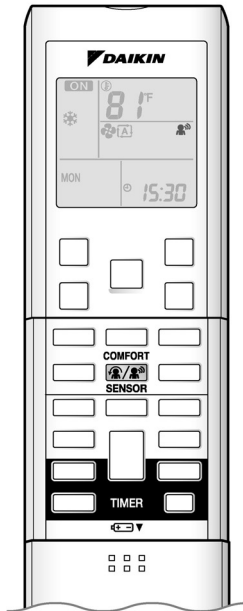

INTELLIGENT EYE Operation



"INTELLIGENT EYE" is the infrared sensor which detects the human movement.

■ To start INTELLIGENT EYE operation

1. Press and select " " on the LCD.

- Each time the  is pressed a different setting option is displayed on the LCD.
- By selecting "" from the following icons, the air conditioner will be in INTELLIGENT EYE operation combined with COMFORT AIRFLOW operation. [▶Page 16](#)



- When the louvers (horizontal blades) are swinging, the operating as above will stop movement of them.

■ To cancel the INTELLIGENT EYE operation

2. Press .

- Press the button to select "Blank".

[EX.]

When somebody in the room

• Normal operation.

The air conditioner is in normal operation while the sensor is detecting the movement of people.

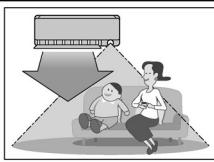

When nobody in the room

• 20 min. after, start energy saving operation.

The set temperature is shifted in $\pm 3.6^{\circ}\text{F}$ ($\pm 2^{\circ}\text{C}$) steps.

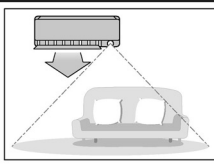

Somebody back in the room

• Back to normal operation.

The air conditioner will return to normal operation when the sensor detects the movement of people again.

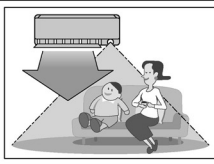

INTELLIGENT EYE Operation

"INTELLIGENT EYE" is useful for energy saving

■ Energy saving operation

- Change the temperature -3.6°F (-2°C) in heating / $+3.6^{\circ}\text{F}$ ($+2^{\circ}\text{C}$) in cooling / $+3.6^{\circ}\text{F}$ ($+2^{\circ}\text{C}$) in dry mode from set temperature.
- Decrease the airflow rate slightly in FAN mode only.
- If no presence detected in the room for 20 minutes.

NOTE

■ Notes on "INTELLIGENT EYE"

- Application range is as follows.

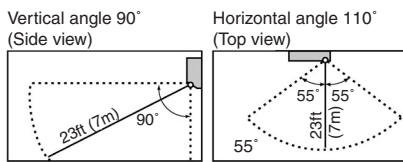

- Sensor may not detect moving objects further than 23ft (7m) away. (Check the application range)
- Sensor detection sensitivity changes according to indoor unit location, the speed of passersby, temperature range, etc.
- The sensor also mistakenly detects pets, sunlight, fluttering curtains and light reflected off of mirrors as passersby.
- INTELLIGENT EYE operation will not go on during POWERFUL operation.
- NIGHT SET mode Page 20 will not go on during use of INTELLIGENT EYE operation.

■ To combine "COMFORT AIRFLOW operation" and "INTELLIGENT EYE operation"

1. Press and select " " on the LCD.

- Each time the is pressed a different setting option is displayed on the LCD.



■ To cancel "COMFORT AIRFLOW operation" and "INTELLIGENT EYE operation"

2. Press .

- Press the button to select "Blank".

- The air conditioner can go into operation with the COMFORT AIRFLOW and INTELLIGENT EYE functions combined.
- The volume of air will be set to AUTO. If the upward and downward airflow direction is selected, the COMFORT AIRFLOW operation will be canceled.
- Priority is given to the function of whichever button is pressed last.

CAUTION

- Do not place large objects near the sensor.
Also keep heating units or humidifiers outside the sensor's detection agree. This sensor can detect undesirable objects.
- Do not hit or violently push the INTELLIGENT EYE sensor. This can lead to damage and malfunction.

2.6 POWERFUL Operation

POWERFUL Operation

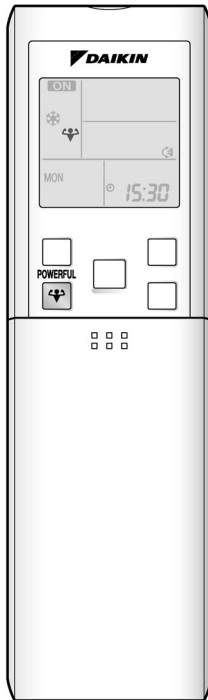

POWERFUL operation quickly maximizes the cooling (heating) effect in any operation mode. You can get the maximum capacity.

■ To start POWERFUL operation

Press  during operation.

- POWERFUL operation ends in 20 minutes. Then the system automatically operates again with the previous settings which were used before POWERFUL operation.
- "" is displayed on the LCD.
- When using POWERFUL operation, there are some functions which are not available.

■ To cancel POWERFUL operation

Press  again.

- "" is no longer displayed on the LCD.

NOTE

■ Notes on POWERFUL operation

- POWERFUL operation cannot be used together with ECONO, COMFORT AIRFLOW or QUIET operation
- POWERFUL operation will not increase the capacity of the air conditioner if the air conditioner is already in operation with its maximum capacity demonstrated.
- **In COOL, HEAT and AUTO operation**
To maximize the cooling (heating) effect, the capacity of outdoor unit is increased and the airflow rate is fixed to the maximum setting.
The temperature and airflow settings are not variable.
- **In DRY operation**
The temperature setting is lowered by 4.5°F (2.5°C) and the airflow rate is slightly increased.
- **In FAN operation**
The airflow rate is fixed to the maximum setting.

2.7 OUTDOOR UNIT QUIET Operation

OUTDOOR UNIT QUIET Operation

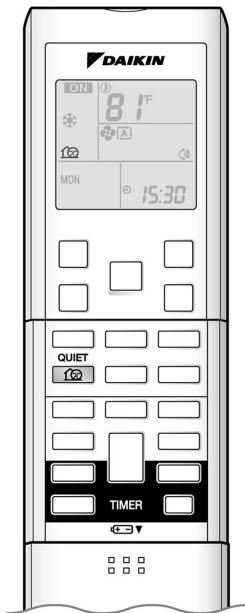

OUTDOOR UNIT QUIET operation lowers the noise level of the outdoor unit by changing the frequency and fan speed on the outdoor unit. This function is convenient during night.

■ To start OUTDOOR UNIT QUIET operation

Press .

- "QUIET" is displayed on the LCD.

■ To cancel OUTDOOR UNIT QUIET operation

Press  again.

- "QUIET" is no longer displayed on the LCD.

NOTE

■ Notes on OUTDOOR UNIT QUIET operation

- This function is available in COOL, HEAT, and AUTO operation.
(This is not available in FAN and DRY operation.)
- POWERFUL operation and OUTDOOR UNIT QUIET operation cannot be used at the same time.
Priority is given to the function of whichever button is pressed last.
- If operation is stopped using the remote controller or the indoor unit ON/OFF switch when using OUTDOOR UNIT QUIET operation, "QUIET" will remain on the remote controller display.
- OUTDOOR UNIT QUIET operation will drop neither the frequency nor fan speed if the frequency and fan speed have been already dropped low enough.

2.8 ECONO Operation

ECONO Operation

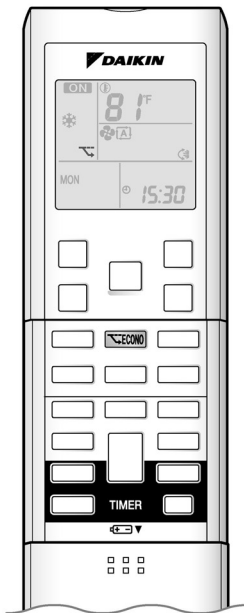

ECONO operation is a function which enables efficient operation by limiting the maximum power consumption value.

This function is useful for cases in which attention should be paid to ensure a circuit breaker will not trip when the product runs alongside other appliances.

■ To start ECONO operation

Press  during operation.

- "ECONO" is displayed on the LCD.

■ To cancel ECONO operation

Press  again.

- "ECONO" is no longer displayed on the LCD.

Running current and power consumption

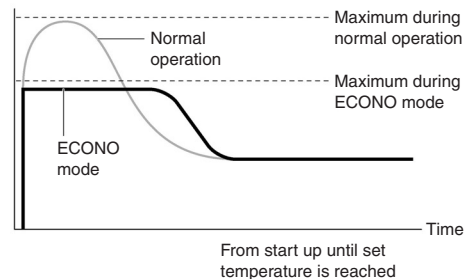

- This diagram is a representation for illustrative purposes only. The maximum running current and power consumption of the air conditioner in ECONO operation vary with the connecting outdoor unit.

NOTE

■ Notes on ECONO operation

- ECONO operation can only be set when the unit is running. Pressing the operation stop button causes the settings to be canceled, and the "ECONO" is no longer displayed on the LCD.
- ECONO operation is a function which enables efficient operation by limiting the power consumption of the outdoor unit (operating frequency).
- ECONO operation functions in AUTO, COOL, DRY, and HEAT operation.
- POWERFUL and ECONO operation cannot be used at the same time. Priority is given to the function of whichever button is pressed last.
- If the level of power consumption is already low, ECONO operation will not drop the power consumption.

2.9 TIMER Operation

TIMER Operation

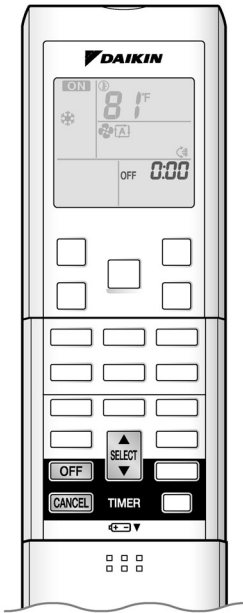

Timer functions are useful for automatically switching the air conditioner on or off at night or in the morning. You can also use OFF TIMER and ON TIMER in combination.

■ To use OFF TIMER operation

- Check that the clock is correct.
If not, set the clock to the present time.

1. Press **OFF**.



- "0:00" is displayed.
- "OFF" blinks.

- "⌚" and day of the week are no longer displayed on the LCD.

2. Press **SELECT** until the time setting reaches the point you like.

- Each pressing of either button increases or decreases the time setting by 10 minutes.
Holding down either button changes the time setting rapidly.

3. Press **OFF** again.

- "OFF" and setting time are displayed on the LCD.
- The TIMER lamp lights up



Control panel

■ To cancel OFF TIMER operation

Press **CANCEL**.

- "OFF" and setting time are no longer displayed on the LCD.
- "⌚" and day of the week are displayed on the LCD.
- The TIMER lamp goes off.

NOTE

■ Notes on TIMER operation

- When TIMER is set, the present time is not displayed.
- Once you set ON, OFF TIMER, the time setting is kept in the memory. (The memory is canceled when remote controller batteries are replaced.)
- When operation the unit via the ON/OFF TIMER, the actual length of operation may vary from the time entered by the user. (Maximum approximately 10 minutes)

■ NIGHT SET mode

When the OFF TIMER is set, the air conditioner automatically adjusts the temperature setting (0.9°F (0.5°C) up in COOL, 3.6°F (2.0°C) down in HEAT) to prevent excessive cooling (heating) for your pleasant sleep.

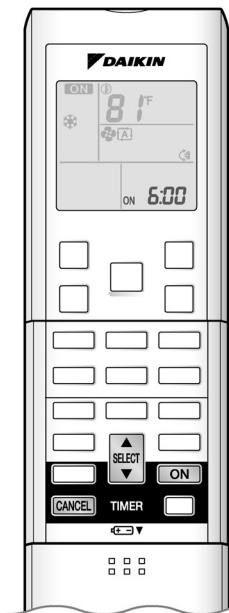

■ To use ON TIMER operation

- Check that the clock is correct.
If not, set the clock to the present time.

1. Press **ON**.



- "⌚" and day of the week are no longer displayed on the LCD.

2. Press **SELECT** until the time setting reaches the point you like.

- Each pressing of either button increases or decreases the time setting by 10 minutes.
Holding down either button changes the time setting rapidly.

3. Press **ON** again.

- "ON" and setting time are displayed on the LCD.
- The TIMER lamp lights up.



Control panel

■ To cancel ON TIMER operation

Press **CANCEL**.

- "ON" and setting time are no longer displayed on the LCD.
- "⌚" and day of the week are displayed on the LCD.
- The TIMER lamp goes off.

■ To combine ON TIMER and OFF TIMER

- A sample setting for combining the 2 timers is shown below.

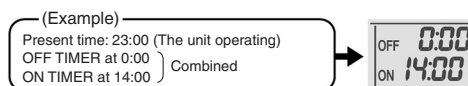

NOTE

■ In the following cases, set the timer again.

- After a breaker has turned off.
- After a power failure.
- After replacing batteries in the remote controller.

2.10 WEEKLY TIMER Operation

WEEKLY TIMER Operation

Up to 4 timer settings can be saved for each day of the week. It is convenient if the WEEKLY TIMER is set according to the family's life style.

■ Using in these cases of WEEKLY TIMER

An example of WEEKLY TIMER settings is shown below.

Example: The same timer settings are made for the week from Monday through Friday while different timer settings are made for the weekend.

<p>[Monday]</p>	<p>Make timer settings up to programs 1-4. ▶ Page 23</p>
<p>[Tuesday to Friday]</p>	<p>Use the copy mode to make settings for Tuesday to Friday, because these settings are the same as those for Monday. ▶ Page 25</p>
<p>[Saturday]</p>	<p>No timer settings</p>
<p>[Sunday]</p>	<p>Make timer settings up to programs 1-4. ▶ Page 23</p>

- Up to 4 reservations per day and 28 reservations per week can be set in the WEEKLY TIMER, The effective use of the copy mode ensures ease of making reservations.
- The use of ON-ON-ON-ON settings, for example, makes it possible to schedule operating mode and set temperature changes. Furthermore, by using OFF-OFF-OFF-OFF settings, only the turn-off time of each day can be set. This will turn off the air conditioner automatically if the user forgets to turn it off.

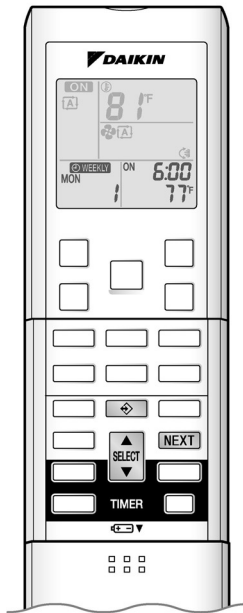

■ To use WEEKLY TIMER operation

Setting mode

- Make sure the day of the week and time are set. If not, set the day of the week and time.

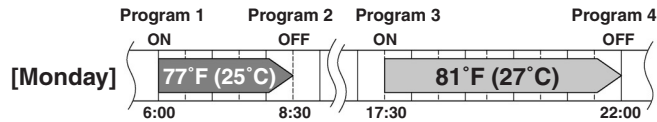

Setting Displays

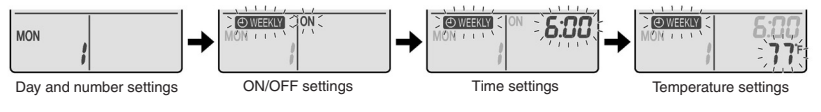

1. Press .

- The day of the week and the reservation number of the current day will be displayed.
- 1 to 4 settings can be made per day.

2. Press to select the desired day of the week and reservation number.

- Pressing  changes the reservation number and the day of the week.

3. Press .

- The day of the week and reservation number will be set.
- "WEEKLY" and "ON" blink.

4. Press to select the desired mode.

- Pressing  changes "ON" or "OFF" setting in sequence.



- In case the reservation has already been set, selecting "blank" deletes the reservation.
- Go to STEP 9 if "blank" is selected.

5. Press .

- The ON/OFF TIMER mode will be set.
- "WEEKLY" and the time blink.

WEEKLY TIMER Operation

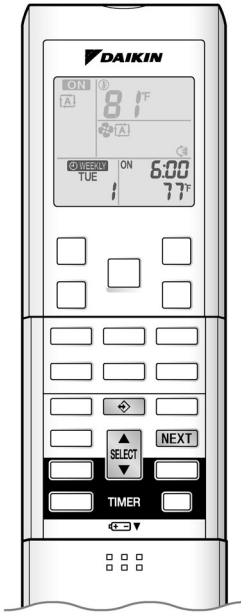

6. Press  to select the desired time.

- The time can be set between 0:00 and 23:50 in 10 minute intervals.
- To return to the ON/OFF TIMER mode setting, press **BACK**.
- Go to **STEP 9** when setting the OFF TIMER.

7. Press .

- The time will be set.
- "**WEEKLY**" and the temperature blink.

8. Press  to select the desired temperature.

- The temperature can be set between 50°F (10°C) and 90°F (32°C).
Cooling: The unit operates at 64°F (18°C) even if it is set at 50 (10) to 63°F (17°C).
Heating: The unit operates at 86°F (30°C) even if it is set at 87 (31) to 90°F (32°C).
- To return to the time setting, press **BACK**.
- The set temperature is only displayed when the mode setting is on.

9. Press .

- The temperature will be set and go to the next reservation setting.
- To continue further settings, repeat the procedure from **STEP 4**.

10. Press  to complete the setting.

- Be sure to direct the remote controller toward the indoor unit and check for a receiving tone and flashing the operation lamp.
- "**WEEKLY**" is displayed on the LCD and WEEKLY TIMER operation is activated.
- The **TIMER** lamp lights up.



Control panel

- A reservation made once can be easily copied and the same settings used for another day of the week. Refer to **Copy mode**.  **Page 25**

NOTE

■ Notes on WEEKLY TIMER operation

- Do not forget to set the clock on the remote controller first.
- The day of the week, ON/OFF TIMER mode, time and set temperature (only for ON TIMER mode) can be set with WEEKLY TIMER. Other settings for ON TIMER are based on the settings just before the operation.
- Both WEEKLY TIMER and ON/OFF TIMER operation cannot be used at the same time. The ON/OFF TIMER operation has priority if it is set while WEEKLY TIMER is still active. The WEEKLY TIMER will go into standby state and "**WEEKLY**" will be no longer displayed on the LCD. When ON/OFF TIMER is up, the WEEKLY TIMER will automatically become active.
- Only the time and set temperature set with the weekly timer are sent with the .
Set the weekly timer only after setting the operation mode, the fan strength, and the fan direction ahead of time.
- Shutting the breaker off, power failure, and other similar events will render operation of the indoor unit's internal clock inaccurate. Reset the clock.
- The **BACK** can be used only for the time and temperature settings.
It cannot be used to go back to the reservation number.

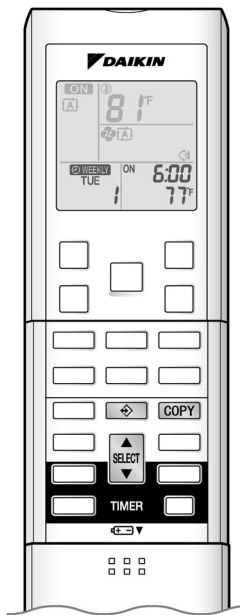





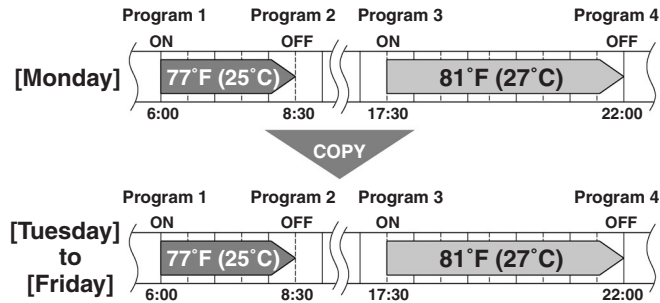

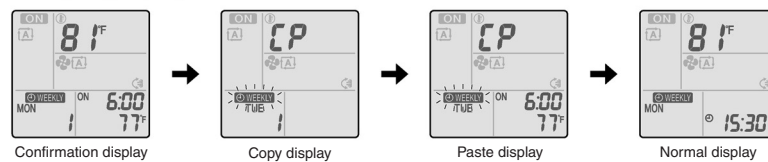

Copy mode

- A reservation made once can be copied another day of the week. The whole reservation of the selected day of the week will be copied.





Setting Displays



1. Press .
2. Press  to confirm the day of the week to be copied.
3. Press  to activate copy mode.
 - The whole reservation of the selected day of the week will be copied.
4. Press  to select the destination day of the week.
5. Press .
 - The reservation will be copied to the selected day of the week. The whole reservation of the selected day of the week will be copied.
 - To continue copying the settings to other days of the week, repeat STEP 4 and STEP 5.
6. Press  to complete the setting.
 - "  WEEKLY " is displayed on the LCD and WEEKLY TIMER operation is activated.

NOTE

■ Notes on copy mode

- The entire reservation of the source day of the week is copied in the copy mode.
- In the case of making a reservation change for any day of the week individually after copying the content of weekly reservations, press  and change the settings in the steps of **Setting mode**.  Page 23

WEEKLY TIMER Operation

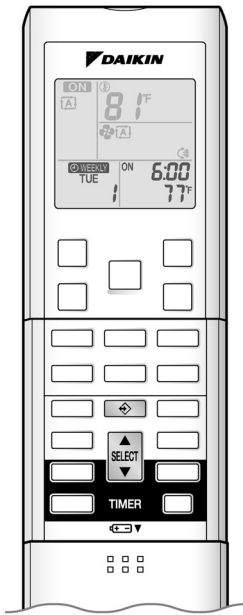

■ Confirming a reservation

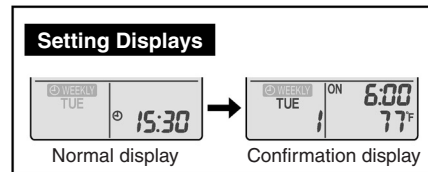

- The reservation can be confirmed.



1. Press .

- The day of the week and the reservation number of the current day will be displayed.

2. Press to select the day of the week and the reservation number to be confirmed.

- Pressing  displays the reservation details.
- To change the confirmed reserved settings, select the reservation number and press . The mode is switched to setting mode. Go to **Setting mode** STEP 4. 

3. Press to exit confirming mode.

- "  " is displayed on the LCD and WEEKLY TIMER operation is activated.
- The TIMER lamp lights up.

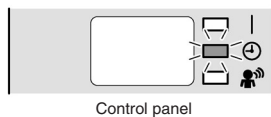

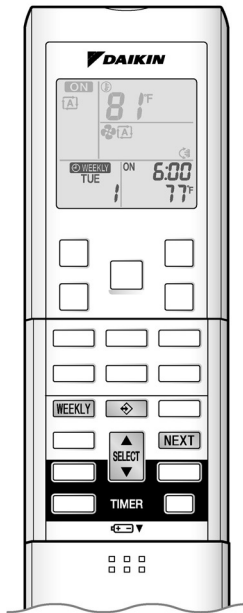

■ To deactivate WEEKLY TIMER operation

Press **WEEKLY** while "**WEEKLY**" is displayed on the LCD.

- The "**WEEKLY**" will be no longer displayed on the LCD.
- The TIMER lamp goes off.
- To reactivate the WEEKLY TIMER operation, press **WEEKLY** again.
- If a reservation deactivated with **WEEKLY** is activated once again, the last reservation mode will be used.

■ To delete reservations

The individual reservation

1. Press .

- The day of the week and the reservation number will be displayed.

2. Press  to select the day of the week and the reservation number to be deleted.

3. Press **NEXT**.

- "**WEEKLY**" and "ON" or "OFF" blink.
- Pressing  changes ON/OFF TIMER mode.
- The reservation will be on setting with selecting "blank".

4. Press  and select "blank".



5. Press **NEXT**.

- The selected reservation is deleted.

WEEKLY TIMER Operation

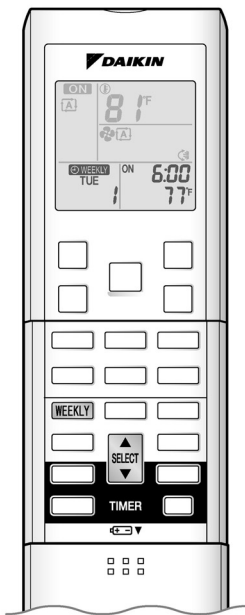

The reservations for each day of the week

- This function can be used for deleting reservations for each day of the week.

1. Press .

2. Press  to select the day of the week to be deleted.

3. Hold **WEEKLY** for 5 seconds.

- The reservation of the selected day of the week will be deleted.

All reservations

Hold **WEEKLY** for 5 seconds while normal display.

- Be sure to direct the remote controller toward the indoor unit and check for a receiving tone.
- This operation is not effective while WEEKLY TIMER is being set.
- All reservations will be deleted.

Part 6

Service Diagnosis

1. Troubleshooting with LED	66
1.1 Indoor Unit.....	66
1.2 Outdoor Unit.....	66
2. Problem Symptoms and Measures	67
3. Service Check Function	68
4. Troubleshooting	71
4.1 Error Codes and Description	71
4.2 Indoor Unit PCB Abnormality	72
4.3 Freeze-up Protection Control or Heating Peak-cut Control.....	73
4.4 Fan Motor (DC Motor) or Related Abnormality.....	75
4.5 Thermistor or Related Abnormality (Indoor Unit).....	77
4.6 Signal Transmission Error (between Indoor Unit and Outdoor Unit)	78
4.7 Unspecified Voltage (between Indoor Unit and Outdoor Unit)	80
4.8 Outdoor Unit PCB Abnormality.....	81
4.9 OL Activation (Compressor Overload)	82
4.10 Compressor Lock	83
4.11 DC Fan Lock	84
4.12 Input Overcurrent Detection	85
4.13 Four Way Valve Abnormality.....	86
4.14 Discharge Pipe Temperature Control.....	88
4.15 High Pressure Control in Cooling	89
4.16 Compressor System Sensor Abnormality	91
4.17 Position Sensor Abnormality	93
4.18 CT or Related Abnormality	95
4.19 Thermistor or Related Abnormality (Outdoor Unit).....	97
4.20 Electrical Box Temperature Rise.....	99
4.21 Radiation Fin Temperature Rise	101
4.22 Output Overcurrent Detection	103
4.23 Refrigerant Shortage	105
4.24 Low-voltage Detection or Over-voltage Detection.....	107
4.25 Signal Transmission Error on Outdoor Unit PCB	109
5. Check	110
5.1 Thermistor Resistance Check	110
5.2 Fan Motor Connector Output Check	111
5.3 Power Supply Waveforms Check.....	111
5.4 Electronic Expansion Valve Check.....	112
5.5 Four-Way Valve Performance Check.....	113
5.6 Inverter Unit Refrigerant System Check.....	113
5.7 “Inverter Checker” Check	114
5.8 Rotation Pulse Check on the Outdoor Unit PCB.....	116
5.9 Installation Condition Check.....	117

5.10 Discharge Pressure Check.....	118
5.11 Outdoor Fan System Check	118
5.12 Capacitor Voltage Check.....	119
5.13 Power Module Check	119

1. Troubleshooting with LED

1.1 Indoor Unit

Operation Lamp

The operation lamp blinks when any of the following errors is detected.

1. When a protection device of the indoor or outdoor unit is activated, or when the thermistor malfunctions.
 2. When a signal transmission error occurs between the indoor and outdoor units.
- In either case, conduct the diagnostic procedure described in the following pages.

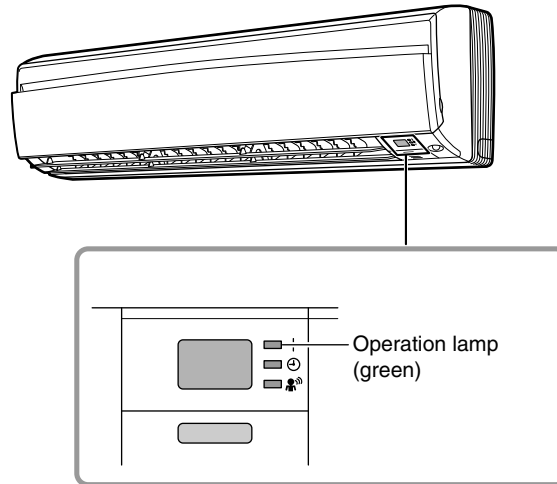

(R9315)

Service Monitor

The indoor unit has one green LED (LED A) on the control PCB. When the microcomputer works in order, the LED A blinks.

1.2 Outdoor Unit

The outdoor unit has one green LED (LED A) on the main PCB. When the microcomputer works in order, the LED A blinks.

2. Problem Symptoms and Measures

Symptom	Check Item	Details of Measure	Reference Page
The unit does not operate.	Check the power supply.	Check if the rated voltage is supplied.	—
	Check the type of the indoor unit.	Check if the indoor unit type is compatible with the outdoor unit.	—
	Check the outdoor temperature.	Heating operation cannot be used when the outdoor temperature is 24°C (75.2°F) or higher, and cooling operation cannot be used when the outdoor temperature is below 10°C (50°F).	—
	Diagnose with remote controller indication.	—	71
	Check the remote controller addresses.	Check if address settings for the remote controller and indoor unit are correct.	186
Operation sometimes stops.	Check the power supply.	A power failure of 2 to 10 cycles stops air conditioner operation. (Operation lamp OFF)	—
	Check the outdoor temperature.	Heating operation cannot be used when the outdoor temperature is 24°C (75.2°F) or higher, and cooling operation cannot be used when the outdoor temperature is below 10°C (50°F).	—
	Diagnose with remote controller indication.	—	71
The unit operates but does not cool, or does not heat.	Check for wiring and piping errors in the connection between the indoor unit and outdoor unit.	—	—
	Check for thermistor detection errors.	Check if the thermistor is mounted securely.	—
	Check for faulty operation of the electronic expansion valve.	Set the unit to cooling operation, and check the temperature of the liquid pipe to see if the electronic expansion valve works.	—
	Diagnose with remote controller indication.	—	71
	Diagnose by service port pressure and operating current.	Check for refrigerant shortage.	105
Large operating noise and vibrations	Check the output voltage of the power module.	—	119
	Check the power module.	—	—
	Check the installation condition.	Check if the required spaces for installation (specified in the installation manual) are provided.	—

3. Service Check Function

Check Method 1

- When the timer cancel button is held down for 5 seconds,  is displayed on the temperature display screen.

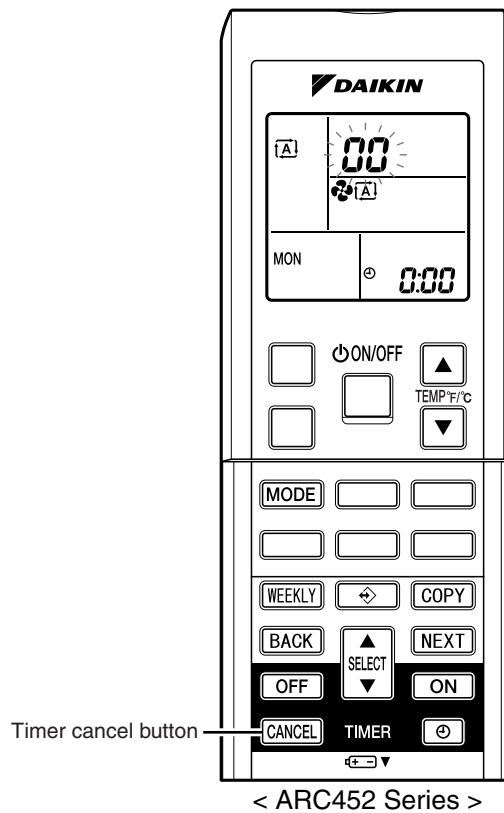

(R14460)

- Press the timer cancel button repeatedly until a long beep sounds.
 - The code indication changes in the sequence shown below.

No.	Code	No.	Code	No.	Code
1	00	13	E7	25	UR
2	U4	14	R3	26	UH
3	L5	15	H8	27	P4
4	E6	16	H9	28	L3
5	H6	17	E9	29	L4
6	H0	18	E4	30	H7
7	R6	19	E5	31	U2
8	E7	20	J3	32	ER
9	U0	21	J6	33	RH
10	F3	22	E5	34	FR
11	R5	23	R1	35	H1
12	F6	24	E1	36	PS



Note:

- A short beep and two consecutive beeps indicate non-corresponding codes.
- To return to the normal mode, hold the timer cancel button down for 5 seconds. When the remote controller is left untouched for 60 seconds, it also returns to the normal mode.
- Not all the error codes are displayed. When you cannot find the error code, try the check method 2. (→ Refer to page 69.)

Check Method 2

1. Press the 3 buttons (TEMP▲, TEMP▼, MODE) simultaneously to enter the diagnosis mode.

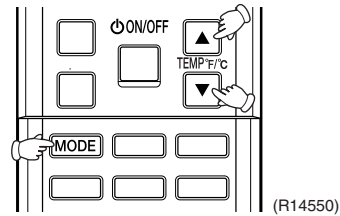

The left-side number blinks.

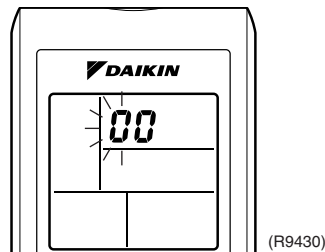

2. Press the TEMP▲ or ▼ button and change the figure until you hear the beep(s).

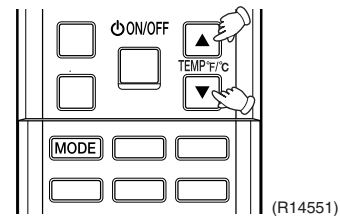

3. Diagnose by the sound.

- ★beep : The left-side number does not correspond with the error code.
 - ★beep beep : The left-side number corresponds with the error code but the right-side number does not.
 - ★long beep : Both the left-side and right-side numbers correspond with the error code.
- Error codes and description → Refer to page 71.

4. Press the MODE button.

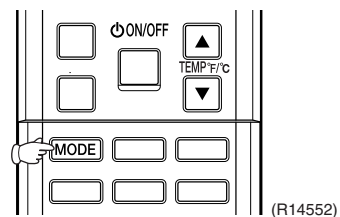

The right-side number blinks.

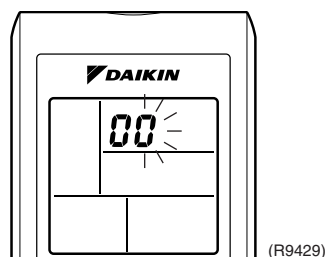

5. Press the TEMP▲ or ▼ button and change the figure until you hear the beep(s).

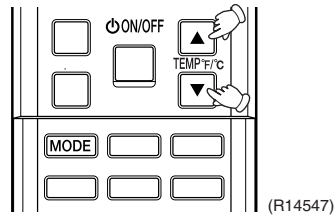

6. Diagnose by the sound.
- ★beep : The left-side number does not correspond with the error code.
 - ★beep beep : The left-side number corresponds with the error code but the right-side number does not.
 - ★long beep : Both the left-side and right-side numbers correspond with the error code.

7. Determine the error code.
The numbers indicated when you hear the long beep are the error code.
Error codes and description → Refer to page 71.

8. Press the MODE button to exit from the diagnosis mode.

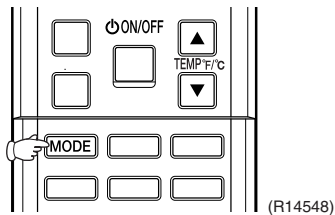

The display 7⁻ means the trial operation mode.
Refer to page 184 for trial operation.

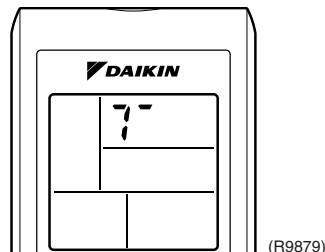

9. Press the ON/OFF button twice to return to the normal mode.

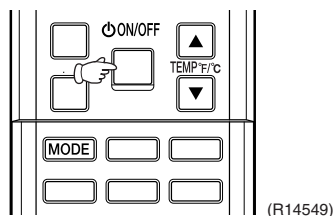

Note: When the remote controller is left untouched for 60 seconds, it returns to the normal mode.

4. Troubleshooting

4.1 Error Codes and Description

	Error Codes	Description	Reference Page
System	00	Normal	—
	U0★	Refrigerant shortage	105
	U2	Low-voltage detection or over-voltage detection	107
	U4	Signal transmission error (between indoor unit and outdoor unit)	78
	UR	Unspecified voltage (between indoor unit and outdoor unit)	80
Indoor Unit	R1	Indoor unit PCB abnormality	72
	RS	Freeze-up protection control or heating peak-cut control	73
	RE	Fan motor (DC motor) or related abnormality	75
	LY	Indoor heat exchanger thermistor or related abnormality	77
	LS	Room temperature thermistor or related abnormality	77
Outdoor Unit	E1	Outdoor unit PCB abnormality	81
	E5★	OL activation (compressor overload)	82
	E6★	Compressor lock	83
	E7★	DC fan lock	84
	E8	Input overcurrent detection	85
	ER	Four way valve abnormality	86
	F3	Discharge pipe temperature control	88
	F6	High pressure control in cooling	89
	H0	Compressor system sensor abnormality	91
	H6	Position sensor abnormality	93
	H8	CT or related abnormality	95
	H9	Outdoor temperature thermistor or related abnormality	97
	U3★	Discharge pipe thermistor or related abnormality	97
	U6	Outdoor heat exchanger thermistor or related abnormality	97
	L3	Electrical box temperature rise	99
	L4	Radiation fin temperature rise	101
	L5★	Output overcurrent detection	103
	P4	Radiation fin thermistor or related abnormality	97
	U7	Signal transmission error on outdoor unit PCB	109

★: Displayed only when system-down occurs.

4.2 Indoor Unit PCB Abnormality

Remote
Controller
Display



Method of
Malfunction
Detection

The system checks if the circuit works properly within the microcomputer of the indoor unit.

Malfunction
Decision
Conditions

The system cannot set the internal settings.

Supposed
Causes

- Wrong models interconnected
- Defective indoor unit PCB
- Disconnection of connector

Troubleshooting

Caution Be sure to turn off the power switch before connecting or disconnecting connectors, or parts may be damaged.

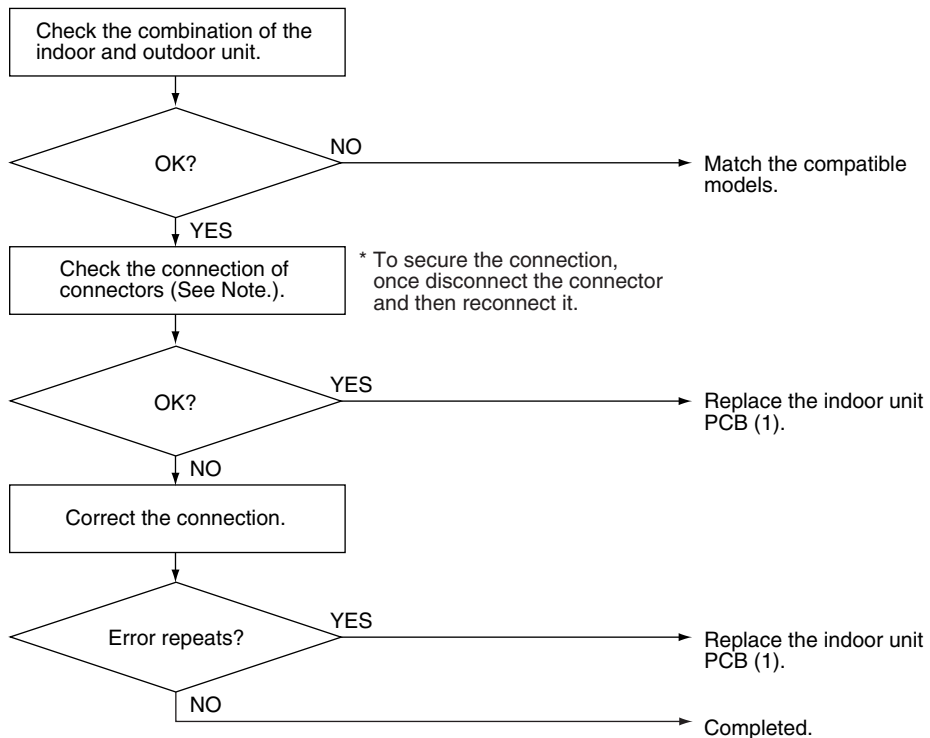

(R11704)



Note: Check the following connector.

Model Type	Connector
Wall Mounted Type	Terminal board ~ Control PCB

4.3 Freeze-up Protection Control or Heating Peak-cut Control

Remote
Controller
Display

85

Method of
Malfunction
Detection

- Freeze-up protection control
During cooling operation, the freeze-up protection control (operation halt) is activated according to the temperature detected by the indoor heat exchanger thermistor.
- Heating peak-cut control
During heating operation, the temperature detected by the indoor heat exchanger thermistor is used for the heating peak-cut control (operation halt, outdoor fan stop, etc.)

Malfunction
Decision
Conditions

- Freeze-up protection control
During cooling operation, the indoor heat exchanger temperature is below 0°C (32°F).
- Heating peak-cut control
During heating operation, the indoor heat exchanger temperature is above 65°C (149°F).

Supposed
Causes

- Short-circuited air
- Clogged air filter of the indoor unit
- Dust accumulation on the indoor heat exchanger
- Defective indoor heat exchanger thermistor
- Defective indoor unit PCB

Troubleshooting



Check No.01
Refer to P.110

**Caution**

Be sure to turn off the power switch before connecting or disconnecting connectors, or parts may be damaged.

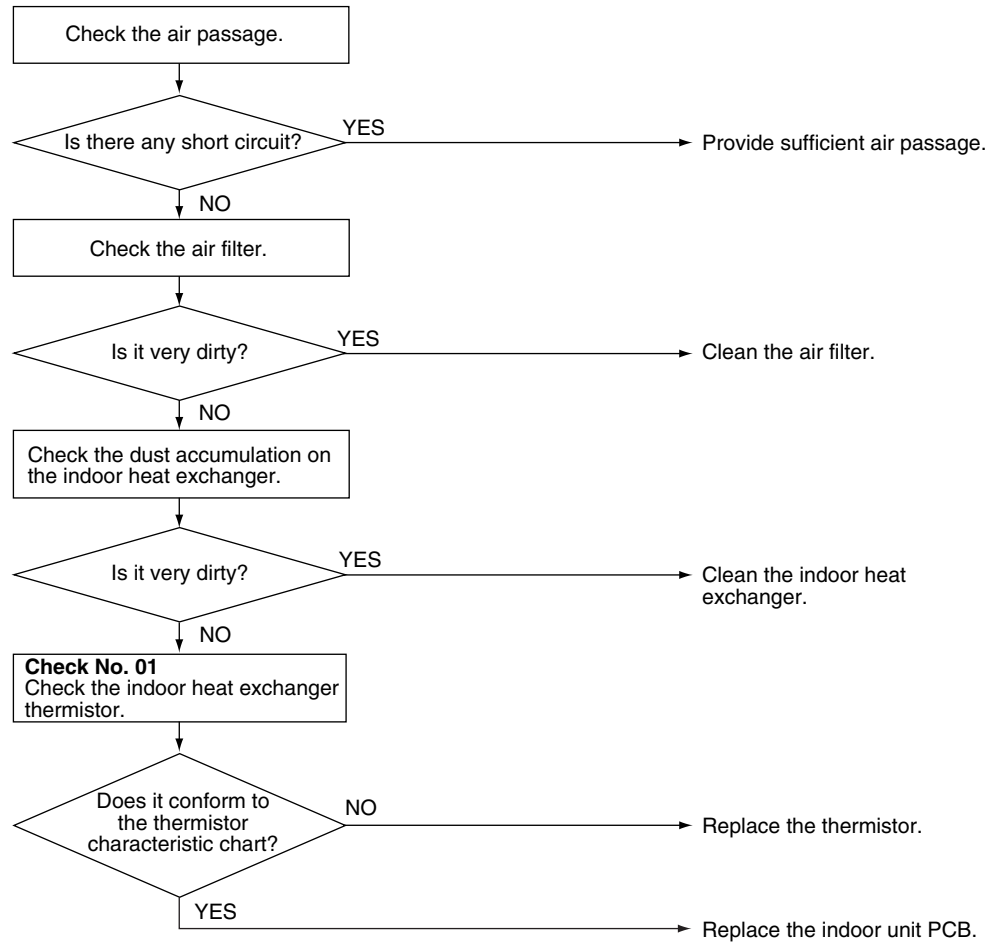

(R14402)

4.4 Fan Motor (DC Motor) or Related Abnormality

**Remote
Controller
Display**

FE

**Method of
Malfunction
Detection**

The rotation speed detected by the Hall IC during fan motor operation is used to determine abnormal fan motor operation.

**Malfunction
Decision
Conditions**

The detected rotation speed does not reach the demanded rotation speed of the target tap, and is less than 50% of the maximum fan motor rotation speed.

**Supposed
Causes**

- Layer short inside the fan motor winding
- Breaking of wire inside the fan motor
- Breaking of the fan motor lead wires
- Defective capacitor of the fan motor
- Defective indoor unit PCB

Troubleshooting



Check No.02
Refer to P.111



Caution

Be sure to turn off the power switch before connecting or disconnecting connectors, or parts may be damaged.

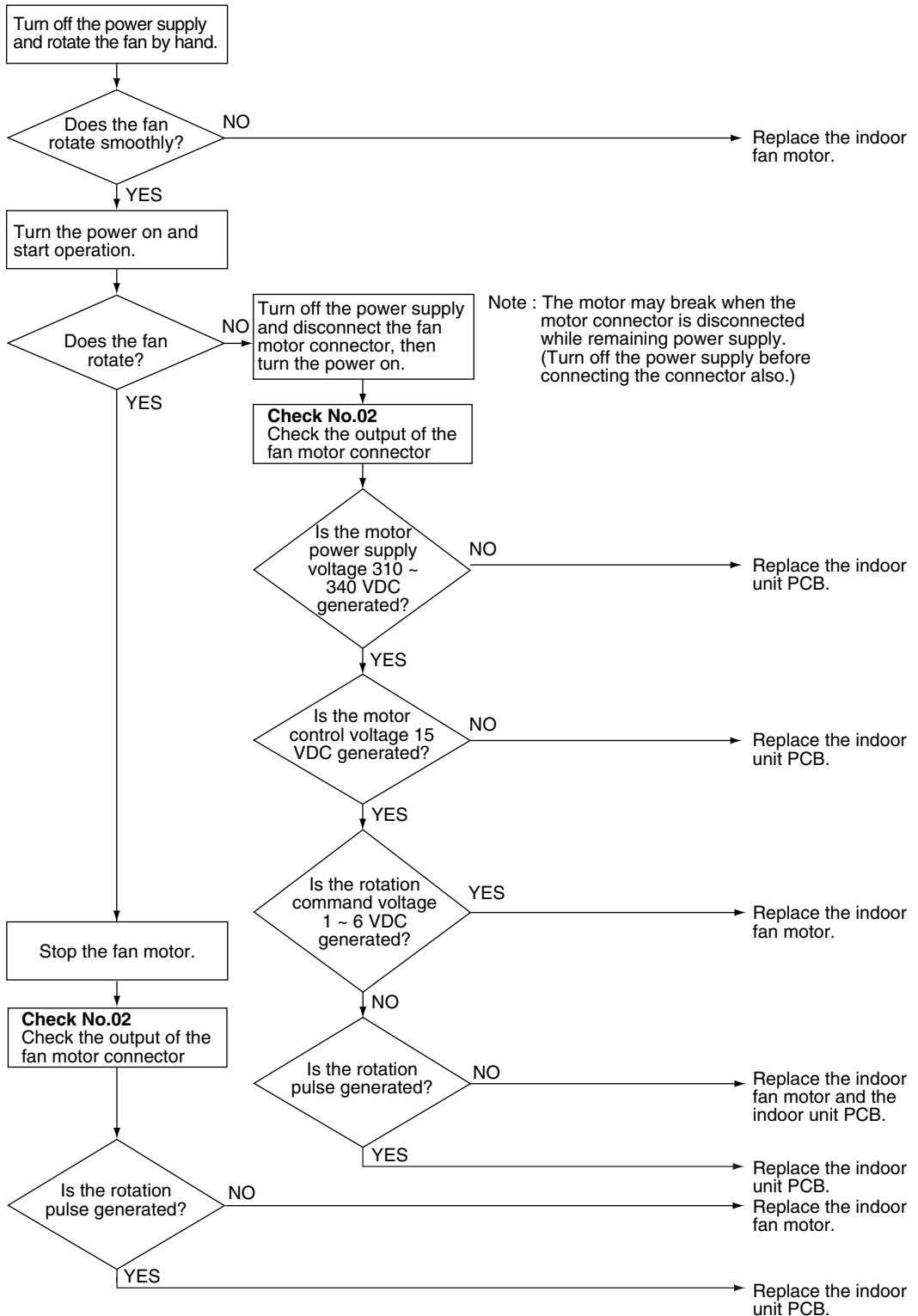

(R14436)

4.5 Thermistor or Related Abnormality (Indoor Unit)

Remote
Controller
Display

Ⓔ4, Ⓔ9

Method of
Malfunction
Detection

The temperatures detected by the thermistors determine thermistor errors.

Malfunction
Decision
Conditions

The thermistor input is more than 4.96 V or less than 0.04 V during compressor operation.

Supposed
Causes

- Disconnection of connector
- Defective thermistor
- Defective indoor unit PCB

Troubleshooting



Check No.01
Refer to P.110



Caution

Be sure to turn off the power switch before connecting or disconnecting connectors, or parts may be damaged.

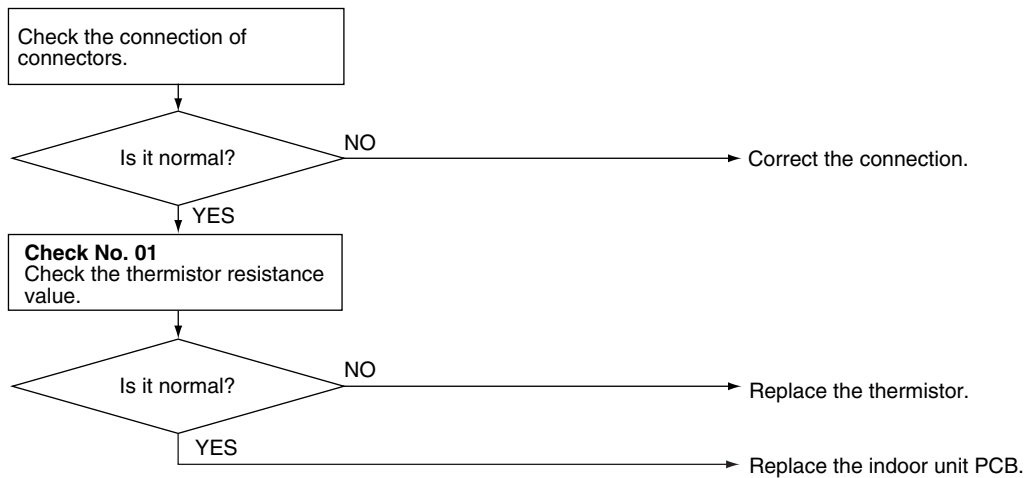

(R14406)

Ⓔ4 : Indoor heat exchanger thermistor

Ⓔ9 : Room temperature thermistor

4.6 Signal Transmission Error (between Indoor Unit and Outdoor Unit)

Remote
Controller
Display



Method of
Malfunction
Detection

The data received from the outdoor unit in indoor unit - outdoor unit signal transmission is checked whether it is normal.

Malfunction
Decision
Conditions

The data sent from the outdoor unit cannot be received normally, or the content of the data is abnormal.

Supposed
Causes

- Wiring error
- Breaking of the connection wires between the indoor and outdoor units (wire No. 3)
- Defective outdoor unit PCB
- Defective indoor unit PCB
- Disturbed power supply waveform

Troubleshooting



Check No.11
Refer to P.111



Caution Be sure to turn off the power switch before connecting or disconnecting connectors, or parts may be damaged.

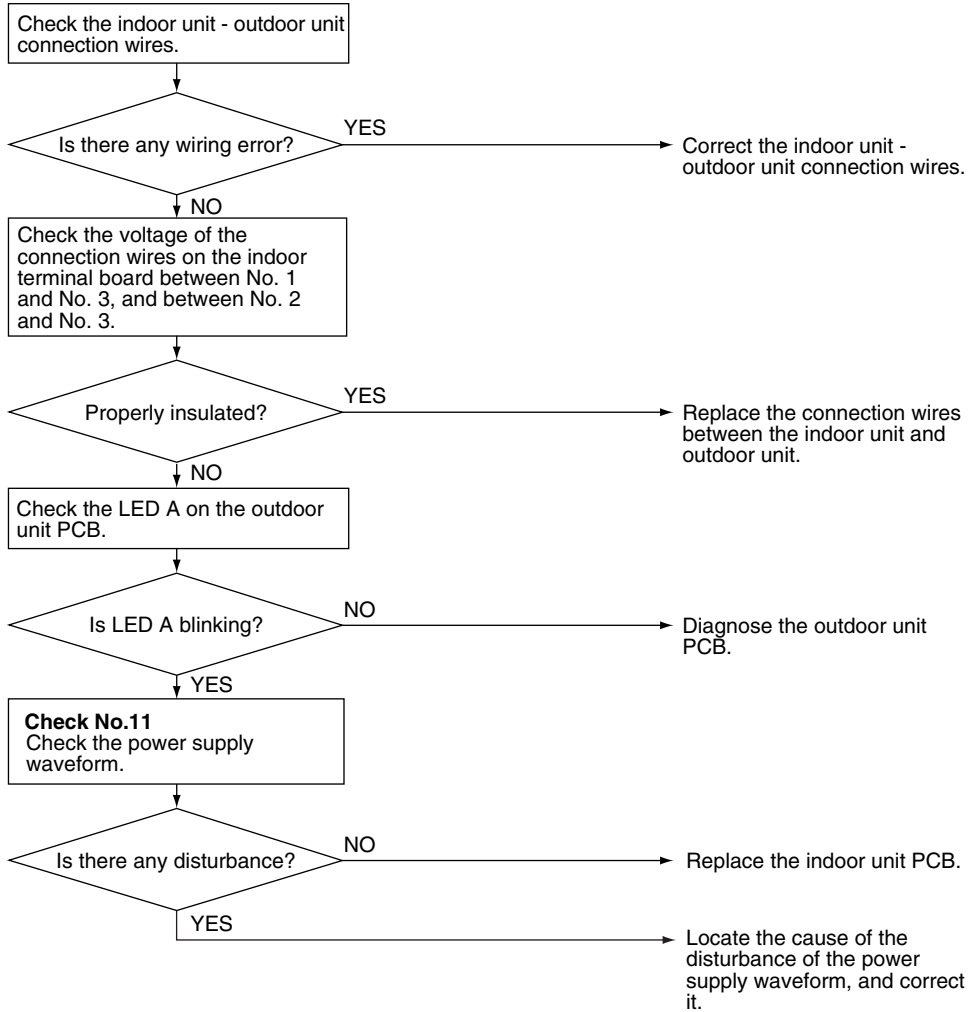

(R14714)

4.7 Unspecified Voltage (between Indoor Unit and Outdoor Unit)

Remote
Controller
Display

UR

Method of
Malfunction
Detection

The supply power is detected for its requirements (different from pair type and multi type) by the indoor / outdoor transmission signal.

Malfunction
Decision
Conditions

The pair type and multi type are interconnected.

Supposed
Causes

- Wrong models interconnected
- Wrong wiring of connecting wires
- Wrong indoor unit PCB or outdoor unit PCB mounted
- Defective indoor unit PCB
- Defective outdoor unit PCB

Troubleshooting



Caution

Be sure to turn off the power switch before connecting or disconnecting connectors, or parts may be damaged.

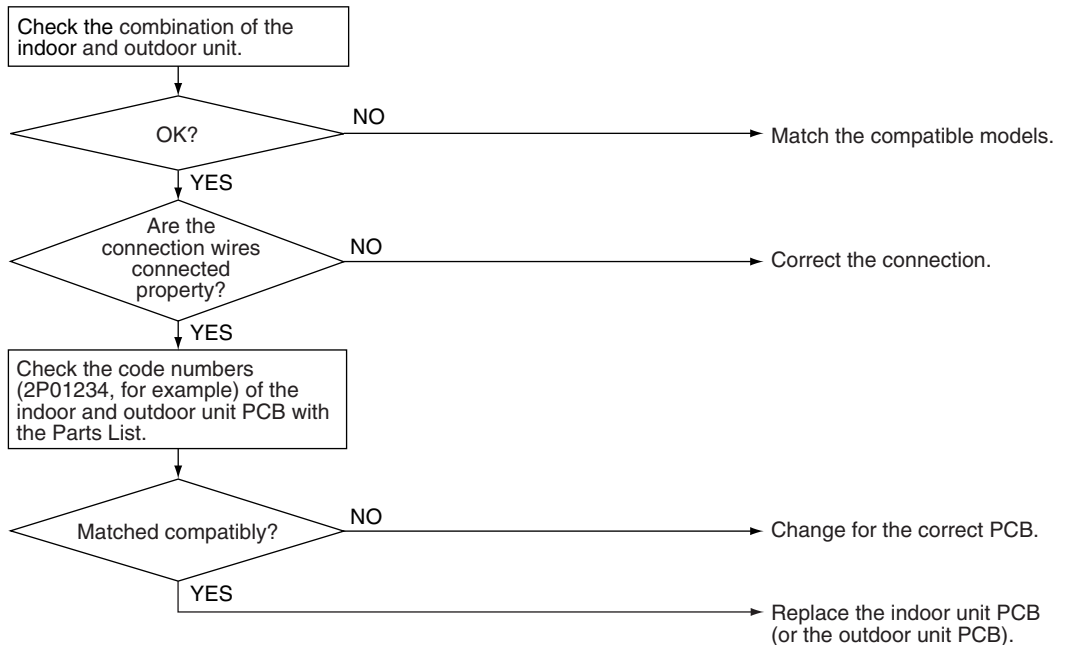

(R11707)

4.8 Outdoor Unit PCB Abnormality

Remote
Controller
Display

E1

Method of
Malfunction
Detection

- The system follows the microprocessor program as specified.
- The system checks to see if the zero-cross signal comes in properly.

Malfunction
Decision
Conditions

- The microprocessor program runs out of control.
- The zero-cross signal is not detected.

Supposed
Causes

- Defective outdoor unit PCB
- Broken harness between PCBs
- Noise
- Momentary fall of voltage
- Momentary power failure

Troubleshooting



Caution

Be sure to turn off the power switch before connecting or disconnecting connectors, or parts may be damaged.

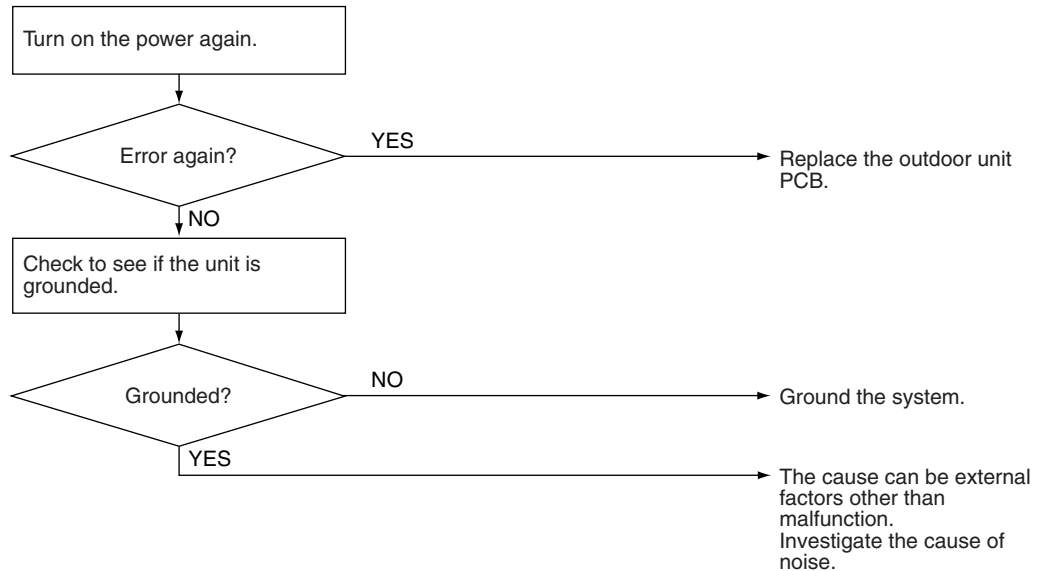

(R7183)

4.9 OL Activation (Compressor Overload)

Remote
Controller
Display



Method of
Malfunction
Detection

A compressor overload is detected through compressor OL.

Malfunction
Decision
Conditions

- If the error repeats, the system is shut down.
- Reset condition: Continuous run for about 60 minutes without any other error
- * The operating temperature condition is not specified.

Supposed
Causes

- Defective discharge pipe thermistor
- Defective electronic expansion valve or coil
- Defective four-way valve or coil
- Defective outdoor unit PCB
- Refrigerant shortage
- Water mixed in refrigerant
- Defective stop valve

Troubleshooting



Check No.01
Refer to P.110



Check No.12
Refer to P.112



Check No.13
Refer to P.113



Check No.14
Refer to P.113



Caution

Be sure to turn off the power switch before connecting or disconnecting connectors, or parts may be damaged.

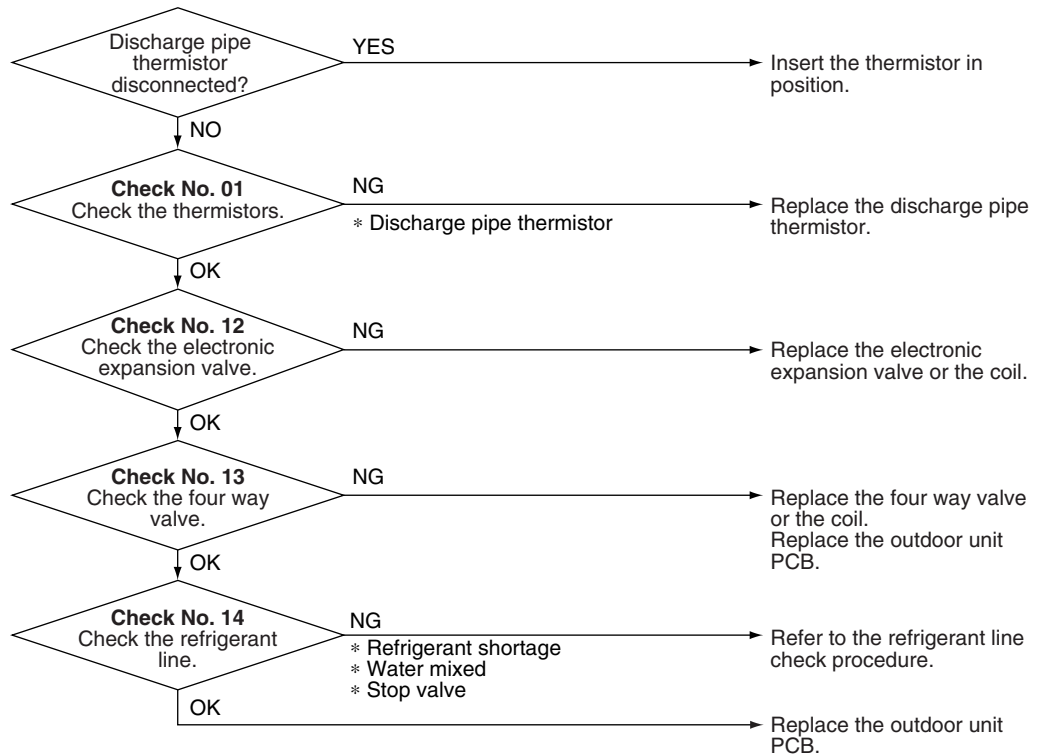

(R14438)

4.10 Compressor Lock

Remote
Controller
Display



Method of
Malfunction
Detection

A compressor lock is detected by the current waveform generated when applying high-frequency voltage to the motor.

Malfunction
Decision
Conditions

- If the error repeats, the system is shut down
- Reset condition: Continuous run for about 5 minutes without any other error

Supposed
Causes

- Compressor locked
- Disconnection of compressor harness

Troubleshooting



Check No.15
Refer to P.114



Caution Be sure to turn off the power switch before connecting or disconnecting connectors, or parts may be damaged.
(Precaution before turning on the power again)
Make sure the power has been off for at least 30 seconds.

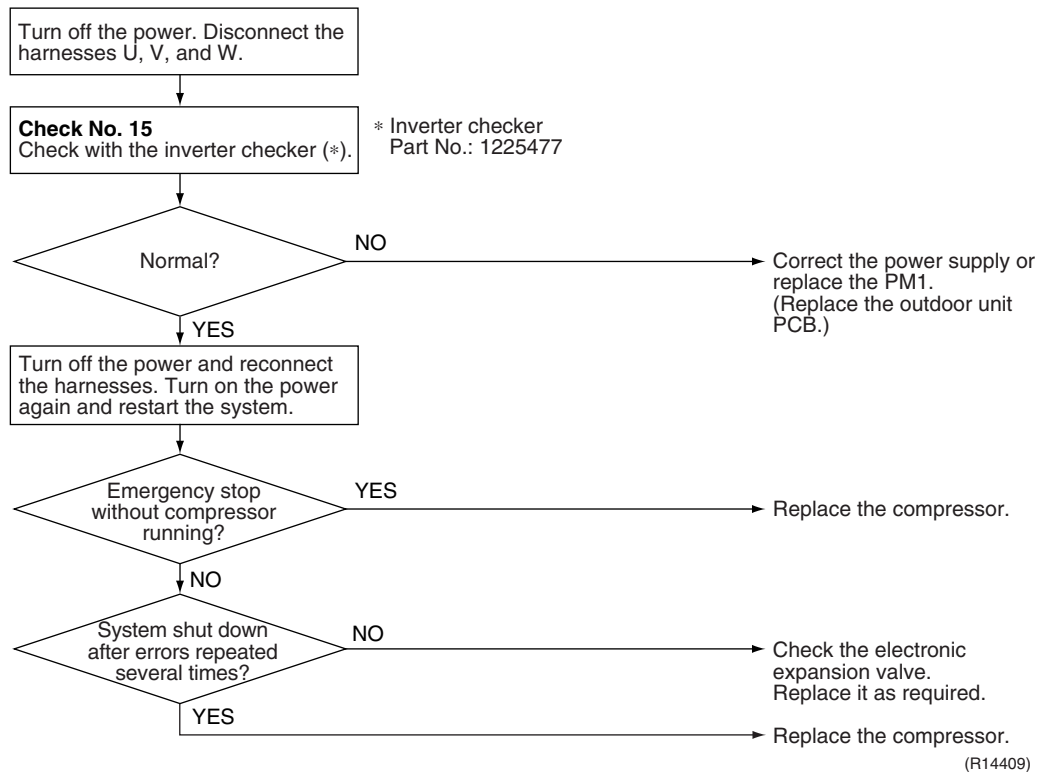

4.11 DC Fan Lock

Remote
Controller
Display



Method of
Malfunction
Detection

An error is determined with the high-voltage fan motor rotation speed detected by the Hall IC.

Malfunction
Decision
Conditions

- The fan does not start in 15 ~ 60 seconds even when the fan motor is running.
- If the error repeats, the system is shut down.
- Reset condition: Continuous run for about 5 minutes without any other error

Supposed
Causes

- Disconnection of fan motor
- Foreign matters stuck in the fan
- Defective fan motor
- Defective outdoor unit PCB

Troubleshooting



Check No.16
Refer to P.116

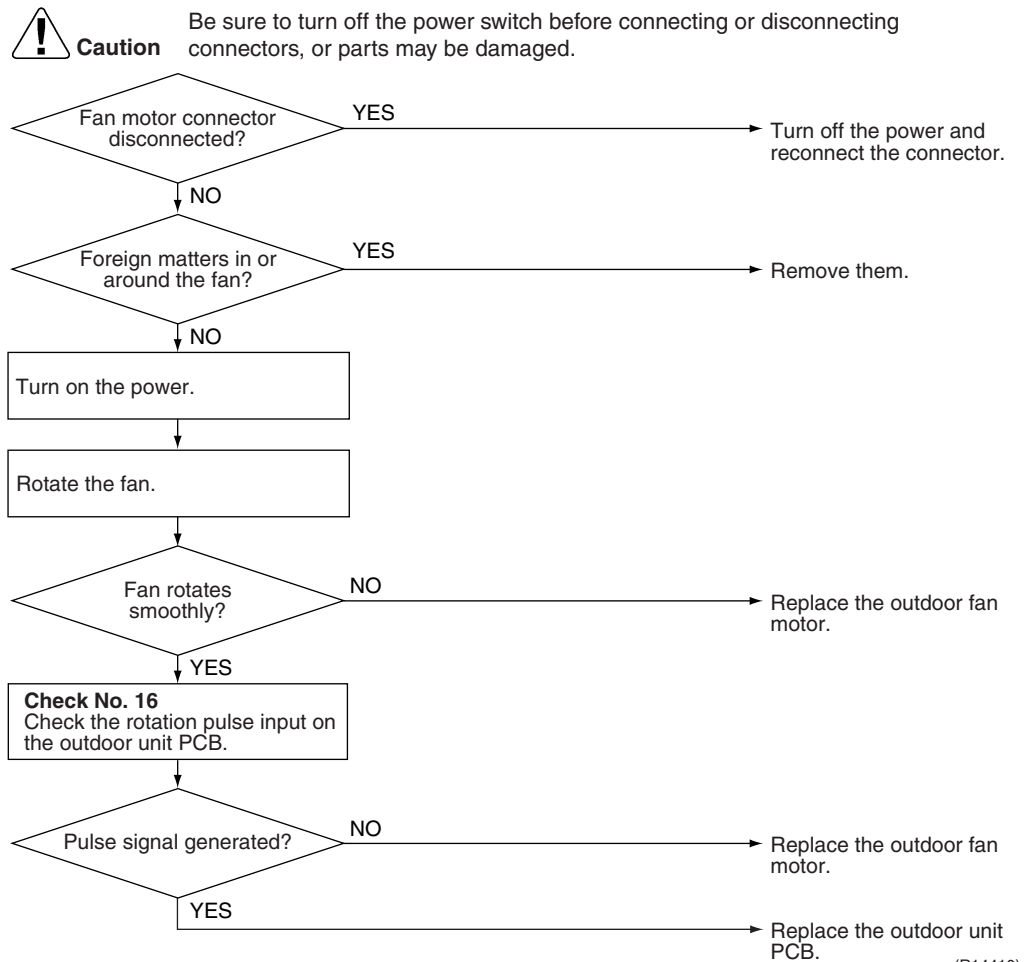

4.12 Input Overcurrent Detection

Remote
Controller
Display



Method of
Malfunction
Detection

An input overcurrent is detected by checking the input current value with the compressor running.

Malfunction
Decision
Conditions

- The current exceeds 20 A for 2.5 seconds with the compressor running. (The upper limit of the current decreases when the outdoor temperature exceeds a certain level.)

Supposed
Causes

- Defective compressor
- Defective power module
- Defective outdoor unit PCB
- Short circuit

Troubleshooting



Check No.15
Refer to P.114



Check No.17
Refer to P.117



Check No.18
Refer to P.118



Caution

Be sure to turn off the power switch before connecting or disconnecting connectors, or parts may be damaged.

* An input overcurrent may result from incorrect internal wiring. If the system is interrupted by an input overcurrent after the wires have been disconnected and reconnected for part replacement, check the wiring again.

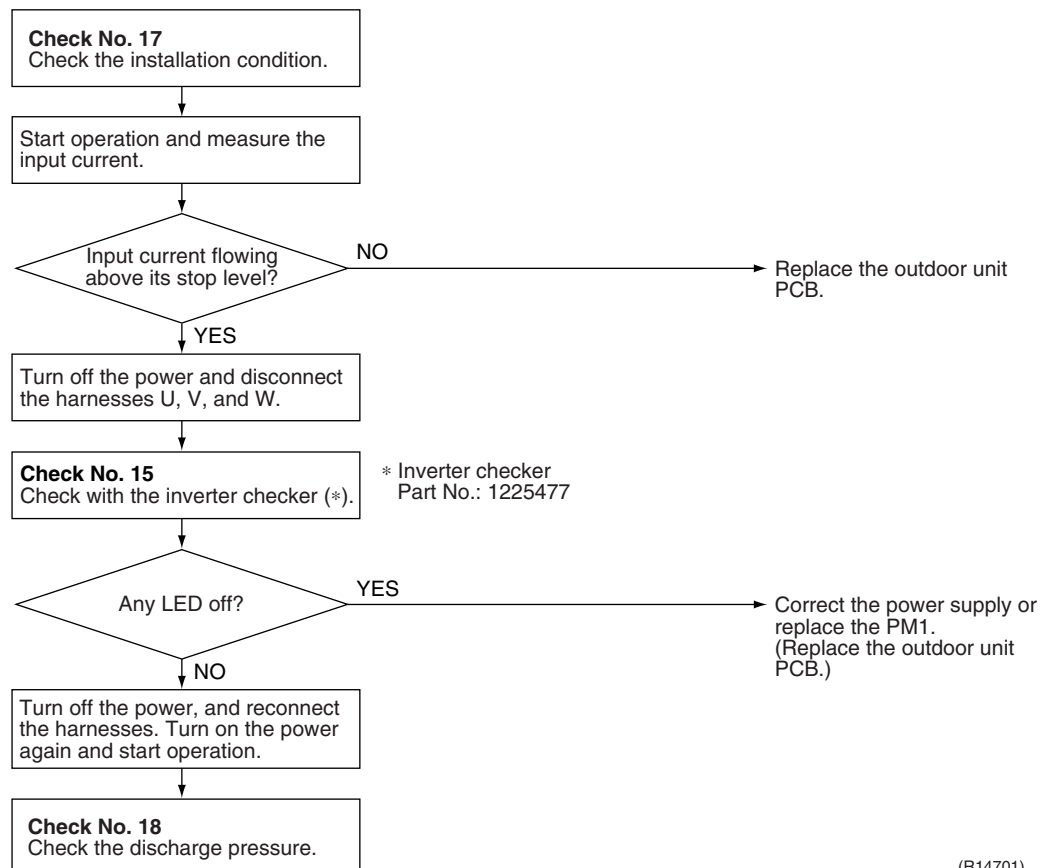

(R14701)

4.13 Four Way Valve Abnormality

Remote
Controller
Display

ER

Method of
Malfunction
Detection

The room temperature thermistor, the indoor heat exchanger thermistor, the outdoor temperature thermistor, and the outdoor heat exchanger thermistor are checked if they function within their normal ranges in each operation mode.

Malfunction
Decision
Conditions

A following condition continues over 1 minute after operating for 10 minutes.

- Cooling / Dry
(room thermistor temp. – indoor heat exchanger temp.) < –5°C (–9°F)
 - Heating
(indoor heat exchanger temp. – room thermistor temp.) < –5°C (–9°F)
 - If the error repeats, the system is shut down.
 - Reset condition: Continuous run for about 60 minutes without any other error
-

Supposed
Causes

- Disconnection of four_way valve coil
- Defective four_way valve, coil, or harness
- Defective outdoor unit PCB
- Defective thermistor
- Refrigerant shortage
- Water mixed in refrigerant
- Defective stop valve

Troubleshooting



Check No.01
Refer to P.110



Check No.13
Refer to P.113



Check No.14
Refer to P.113



Caution Be sure to turn off the power switch before connecting or disconnecting connectors, or parts may be damaged.

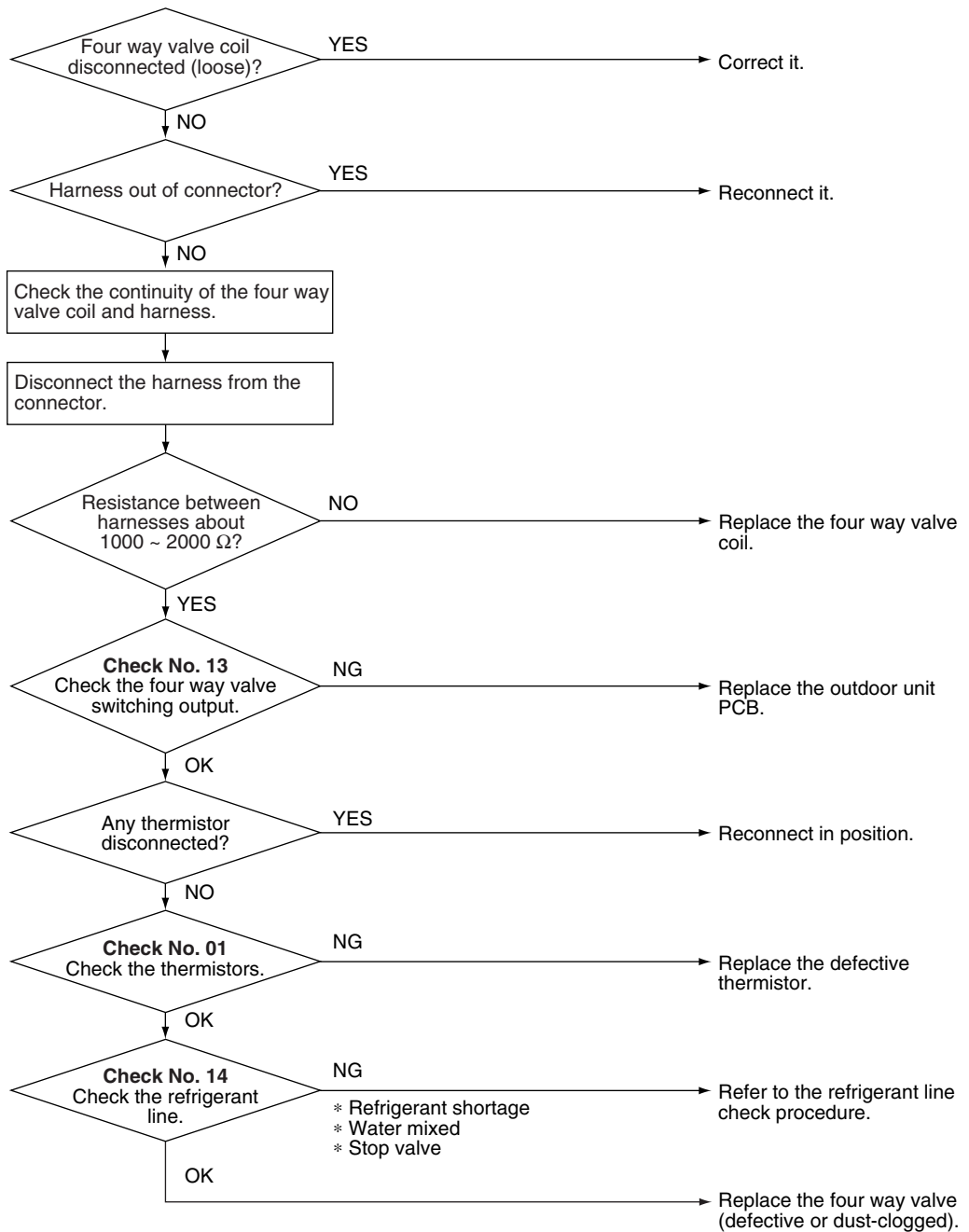

(R14441)

4.14 Discharge Pipe Temperature Control

Remote
Controller
Display



Method of
Malfunction
Detection

An error is determined with the temperature detected by the discharge pipe thermistor.

Malfunction
Decision
Conditions

- If the temperature detected by the discharge pipe thermistor rises above 120°C (248°F), the compressor stops.
- The error is cleared when the discharge pipe temperature has dropped below 107°C (224.6°F).
- If the error repeats, the system is shut down.
- Reset condition: Continuous run for about 60 minutes without any other error

Supposed
Causes

- Defective discharge pipe thermistor
(Defective outdoor heat exchanger thermistor or outdoor temperature thermistor)
- Defective electronic expansion valve or coil
- Refrigerant shortage
- Defective four way valve
- Water mixed in refrigerant
- Defective stop valve
- Defective outdoor unit PCB

Troubleshooting



Check No.01
Refer to P.110



Check No.12
Refer to P.112



Check No.14
Refer to P.113

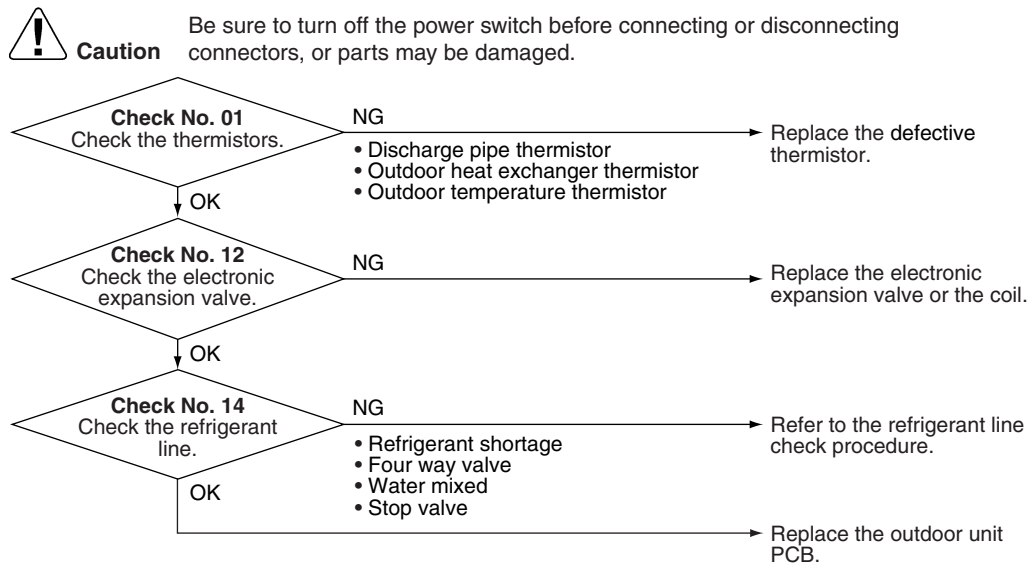

(R14412)

4.15 High Pressure Control in Cooling

**Remote
Controller
Display**

FE

**Method of
Malfunction
Detection**

High-pressure control (operation halt, frequency drop, etc.) is activated in cooling operation if the temperature sensed by the outdoor heat exchanger thermistor exceeds the limit.

**Malfunction
Decision
Conditions**

- The temperature sensed by the outdoor heat exchanger thermistor rises above about 65°C (149°F).
 - The error is cleared when the temperature drops below about 50°C (122°F).
-

**Supposed
Causes**

- The installation space is not large enough.
- Dirty outdoor heat exchanger
- Defective outdoor fan motor
- Defective stop valve
- Defective electronic expansion valve or coil
- Defective outdoor heat exchanger thermistor
- Defective outdoor unit PCB

Troubleshooting



Check No.01
Refer to P.110



Check No.12
Refer to P.112



Check No.17
Refer to P.117



Check No.18
Refer to P.118



Check No.19
Refer to P.118

Turn off the power switch before connecting or disconnecting parts may be damaged.



NG → Change the installation location or direction.
Clean the outdoor heat exchanger.

4.16 Compressor System Sensor Abnormality

**Remote
Controller
Display**



**Method of
Malfunction
Detection**

- The system checks the supply voltage and the DC voltage before the compressor starts.
 - The system checks the compressor current right after the compressor starts.
-

**Malfunction
Decision
Conditions**

- The supply voltage and the DC voltage is obviously low or high.
 - The compressor current does not run when the compressor starts.
-

**Supposed
Causes**

- Disconnection of reactor
- Disconnection of compressor harness
- Defective outdoor unit PCB
- Defective compressor

Troubleshooting

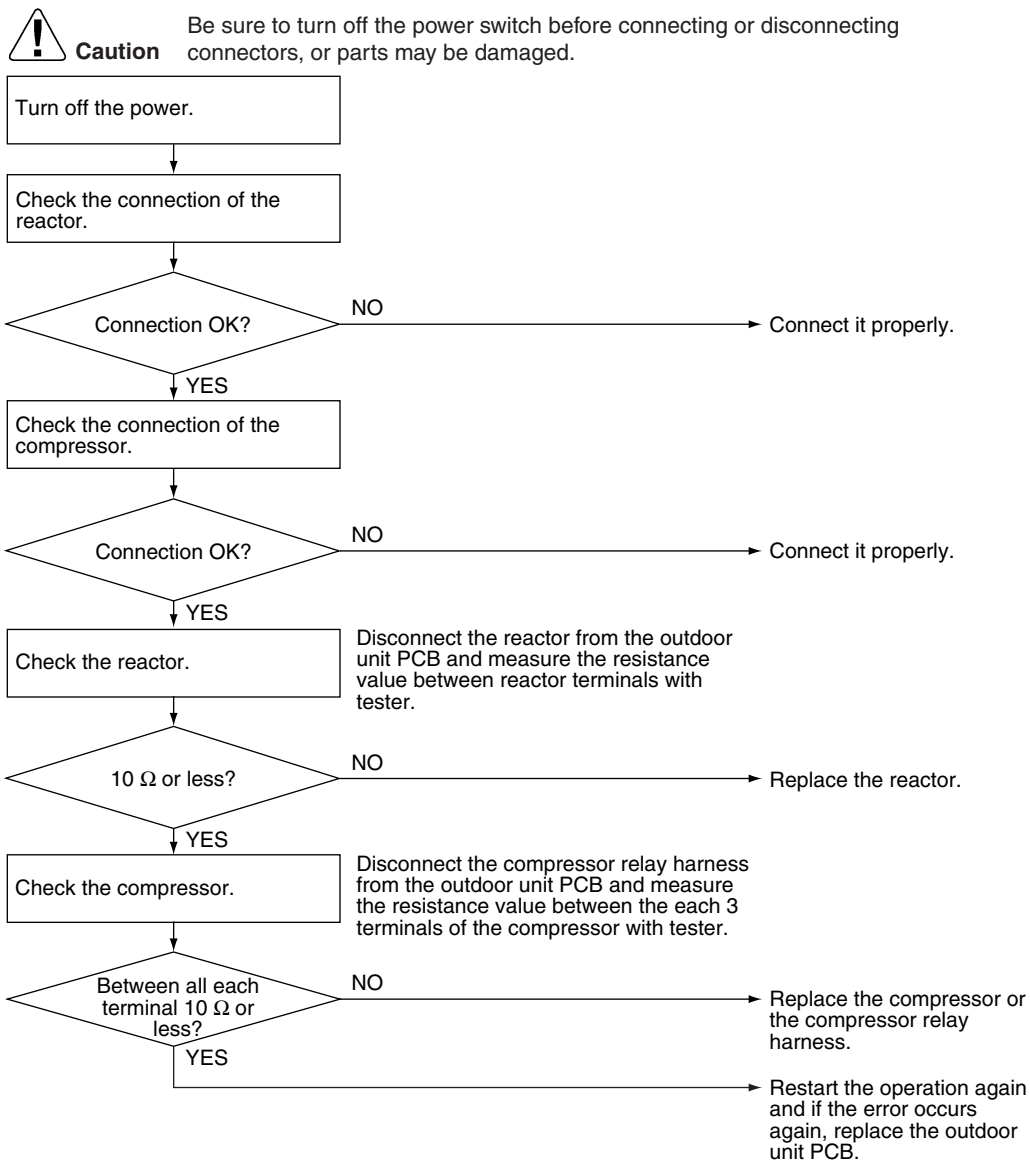

(R7174)

4.17 Position Sensor Abnormality

**Remote
Controller
Display**

H6

**Method of
Malfunction
Detection**

A compressor start-up failure is detected by checking the compressor running condition through the position detection circuit.

**Malfunction
Decision
Conditions**

- If the error repeats, the system is shut down.
- Reset condition: Continuous run for about 5 minutes without any other error

**Supposed
Causes**

- Disconnection of compressor relay harness
- Defective compressor
- Defective outdoor unit PCB
- Start-up failure caused by the closed stop valve
- Input voltage is out of specification

Troubleshooting



Check No.15
Refer to P.114



Check No.18
Refer to P.118

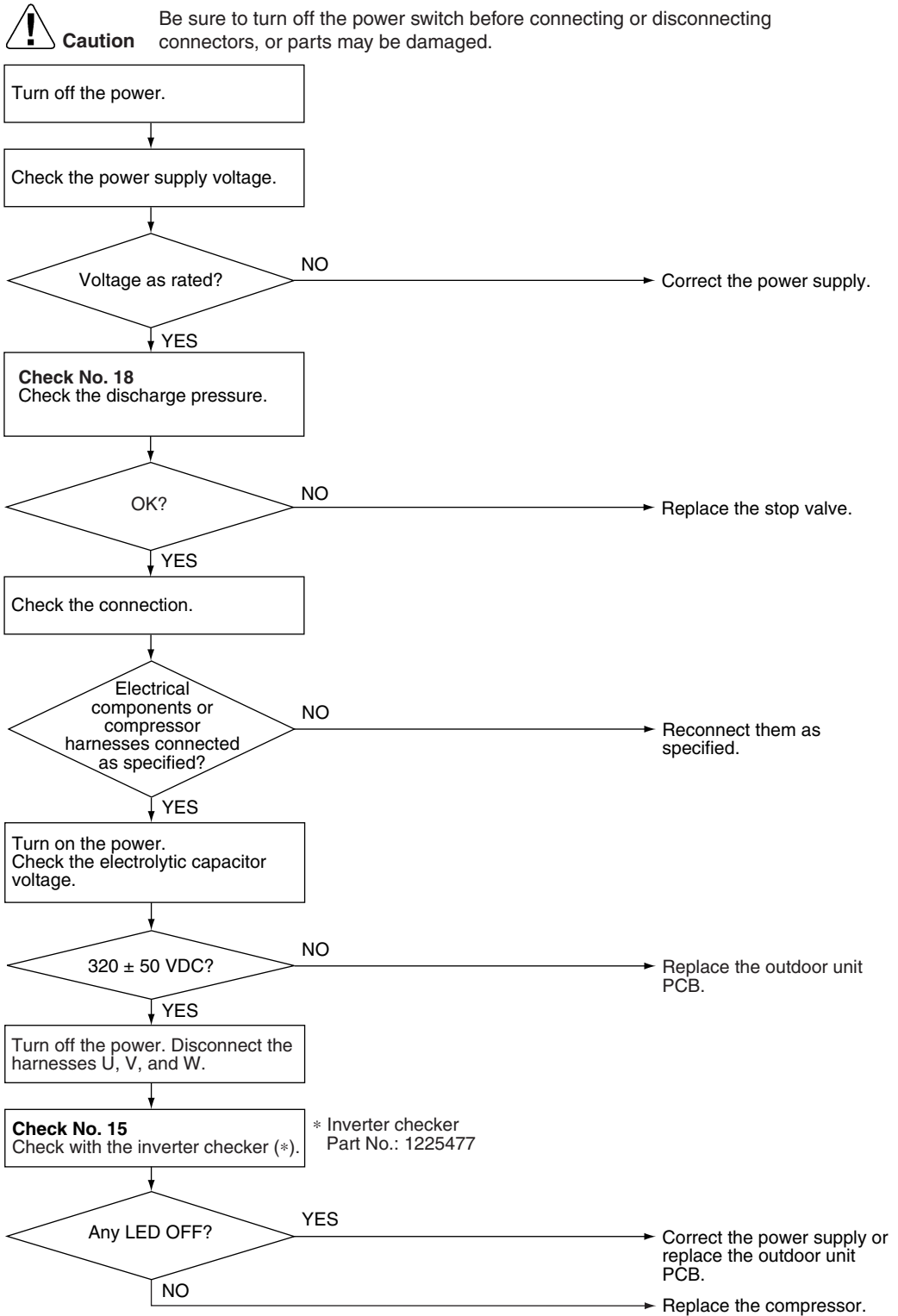

(R14461)

4.18 CT or Related Abnormality

Remote
Controller
Display

H8

Method of
Malfunction
Detection

A CT or related error is detected by checking the compressor running frequency and CT-detected input current.

Malfunction
Decision
Conditions

- The compressor running frequency is more than **A** Hz, and the CT input current is below **B** A.

A (Hz)	B (A)
32	0.5

- If the error repeats, the system is shut down.
- Reset condition: Continuous run for about 60 minutes without any other error

Supposed
Causes

- Defective power module
- Breakage of wiring or disconnection
- Defective reactor
- Defective outdoor unit PCB

Troubleshooting



Check No.15
Refer to P.114



Check No.21
Refer to P.119



Caution Be sure to turn off the power switch before connecting or disconnecting connectors, or parts may be damaged.

Turn off the power and turn it on again.

Start operation.

* Running current as shown at right with relay cable 1 or 2?

YES → Replace the outdoor unit PCB.

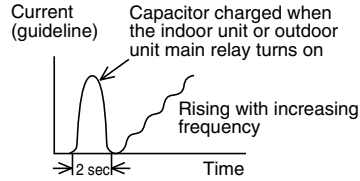

Check No. 21
Check the capacitor voltage.

320 ± 50 VDC?

YES → Turn off the power. Disconnect the harnesses U, V, and W.

Measure the rectifier input voltage.

Check No. 15
Check with the inverter checker (*).
* Inverter checker Part No.: 1225477

Any LED OFF?
YES → Correct the power supply or replace the PM1. (Replace the outdoor unit PCB.)
NO →

Turn off the power and reconnect the harnesses. Then turn on the power again and restart operation.

Compressor running?
YES → Replace the outdoor unit PCB.
NO → Replace the compressor.

Voltage within the allowable range (Supply voltage ± 15%)?
YES → Replace the outdoor unit PCB.
NO → Check the supply voltage.

(R14463)

4.19 Thermistor or Related Abnormality (Outdoor Unit)

<p>Remote Controller Display</p>	<p><i>H3, U3, U6, P4</i></p>
<p>Method of Malfunction Detection</p>	<p>This fault is identified based on the thermistor input voltage to the microcomputer. A thermistor fault is identified based on the temperature sensed by each thermistor.</p>
<p>Malfunction Decision Conditions</p>	<ul style="list-style-type: none"> ■ The thermistor input voltage is above 4.96 V or below 0.04 V with the power on. ■ <i>U3</i> error is judged if the discharge pipe temperature is lower than the heat exchanger temperature.
<p>Supposed Causes</p>	<ul style="list-style-type: none"> ■ Disconnection of the connector for the thermistor ■ Defective thermistor corresponding to the error code ■ Defective heat exchanger thermistor in the case of <i>U3</i> error (outdoor heat exchanger thermistor in cooling operation, or indoor heat exchanger thermistor in heating operation) ■ Defective outdoor unit PCB ■ Defective indoor unit PCB
<p>Troubleshooting</p>	<p>In case of “<i>P4</i>”</p> <p> Caution Be sure to turn off the power switch before connecting or disconnecting connectors, or parts may be damaged.</p> <p>Replace the outdoor unit PCB.</p> <p><i>P4</i> : Radiation fin thermistor</p>

Troubleshooting



Check No.01
Refer to P.110

In case of "H3" "J3" "J5"



Caution

Be sure to turn off the power switch before connecting or disconnecting connectors, or parts may be damaged.

Turn on the power again.

Error displayed again on remote controller?

NO → Reconnect the connectors or thermistors.

Check No. 01
Check the thermistor resistance value.

Normal?

NO → Replace the defective one(s) of the following thermistors.
* Outdoor temperature thermistor
* Discharge pipe thermistor
* Outdoor heat exchanger thermistor

J3 error: the discharge pipe temperature is lower than the heat exchanger temperature.

Cooling: Outdoor heat exchanger temperature

Heating: Indoor heat exchanger temperature

Check No. 01
Check the indoor heat exchanger thermistor resistance value in the heating operation.

Indoor heat exchanger thermistor functioning?

NO → Replace the indoor heat exchanger thermistor.

YES → Replace the outdoor unit PCB.
(Replace the indoor unit PCB.)

(R14464)

- H3 : Outdoor temperature thermistor
- J3 : Discharge pipe thermistor
- J5 : Outdoor heat exchanger thermistor

4.20 Electrical Box Temperature Rise

Remote
Controller
Display



Method of
Malfunction
Detection

An electrical box temperature rise is detected by checking the radiation fin thermistor with the compressor off.

Malfunction
Decision
Conditions

- With the compressor off, the radiation fin temperature is above **A**.
- The error is cleared when the radiation fin temperature drops below **B**.
- To cool the electrical components, the outdoor fan starts when the radiation fin temperature rises above **C** and stops when it drops below **B**.

A	100°C (212°F)
B	70°C (158°F)
C	85°C (185°F)

Supposed
Causes

- Defective outdoor fan motor
- Short circuit
- Defective radiation fin thermistor
- Disconnection of connector
- Defective outdoor unit PCB

Troubleshooting



Check No.17
Refer to P.117



Check No.19
Refer to P.118



Caution

Be sure to turn off the power switch before connecting or disconnecting connectors, or parts may be damaged.

Turn off the power and turn it on again.



WARNING

To cool the electrical components, the outdoor fan starts when the radiation fin temperature rises above **C** and stops when it drops below **B**.

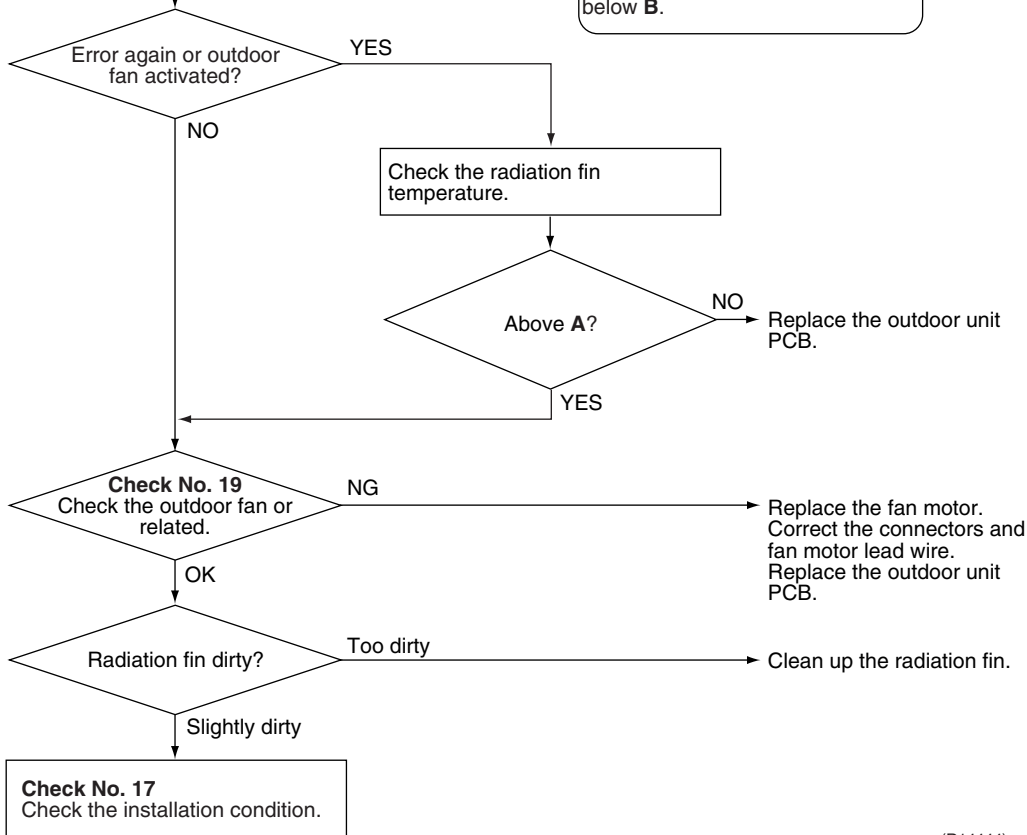

(R14444)

A	100°C (212°F)
B	70°C (158°F)
C	85°C (185°F)

4.21 Radiation Fin Temperature Rise

Remote
Controller
Display

L4

Method of
Malfunction
Detection

A radiation fin temperature rise is detected by checking the radiation fin thermistor with the compressor on.

Malfunction
Decision
Conditions

- If the radiation fin temperature with the compressor on is above **A**.
- The error is cleared when the radiation fin temperature drops below **B**.
- If the error repeats, the system is shut down.
- Reset condition: Continuous run for about 60 minutes without any other error

A	105°C (221°F)
B	97°C (206.6°F)

Supposed
Causes

- Defective outdoor fan motor
- Short circuit
- Defective radiation fin thermistor
- Disconnection of connector
- Defective outdoor unit PCB
- Silicon grease is not applied properly on the radiation fin after replacing the outdoor unit PCB.

Troubleshooting

 **Check No.17**
Refer to P.117

 **Check No.19**
Refer to P.118

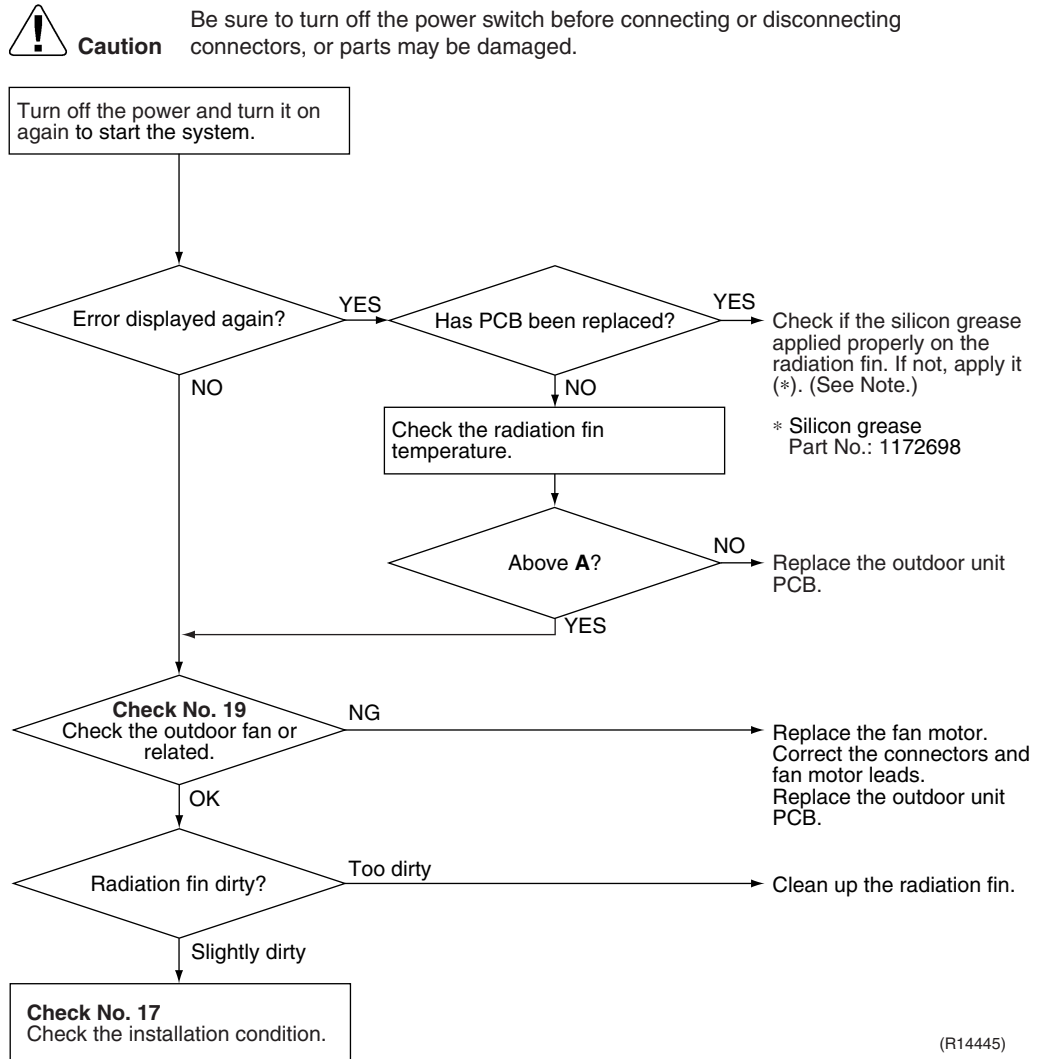

(R14445)

A	105°C (221°F)
----------	---------------

 **Note:** Refer to “Application of silicon grease to a power transistor and a diode bridge” on page 188 for detail.

4.22 Output Overcurrent Detection

<p>Remote Controller Display</p>	<p>LS</p>
<p>Method of Malfunction Detection</p>	<p>An output overcurrent is detected by checking the current that flows in the inverter DC section.</p>
<p>Malfunction Decision Conditions</p>	<ul style="list-style-type: none"> ■ A position signal error occurs while the compressor is running. ■ A speed error occurs while the compressor is running. ■ An output overcurrent signal is fed from the output overcurrent detection circuit to the microcomputer. ■ If the error repeats, the system is shut down. ■ Reset condition: Continuous run for about 5 minutes without any other error
<p>Supposed Causes</p>	<ul style="list-style-type: none"> ■ Poor installation condition ■ Closed stop valve ■ Defective power module ■ Wrong internal wiring ■ Abnormal supply voltage ■ Defective outdoor unit PCB ■ Defective compressor

Troubleshooting



Check No.15
Refer to P.114



Check No.17
Refer to P.117



Check No.18
Refer to P.118



Check No.22
Refer to P.119



Caution Be sure to turn off the power switch before connecting or disconnecting connectors, or parts may be damaged.

* An output overcurrent may result from wrong internal wiring. If the system is interrupted by an output overcurrent after the wires have been disconnected and reconnected for part replacement, check the wiring again.

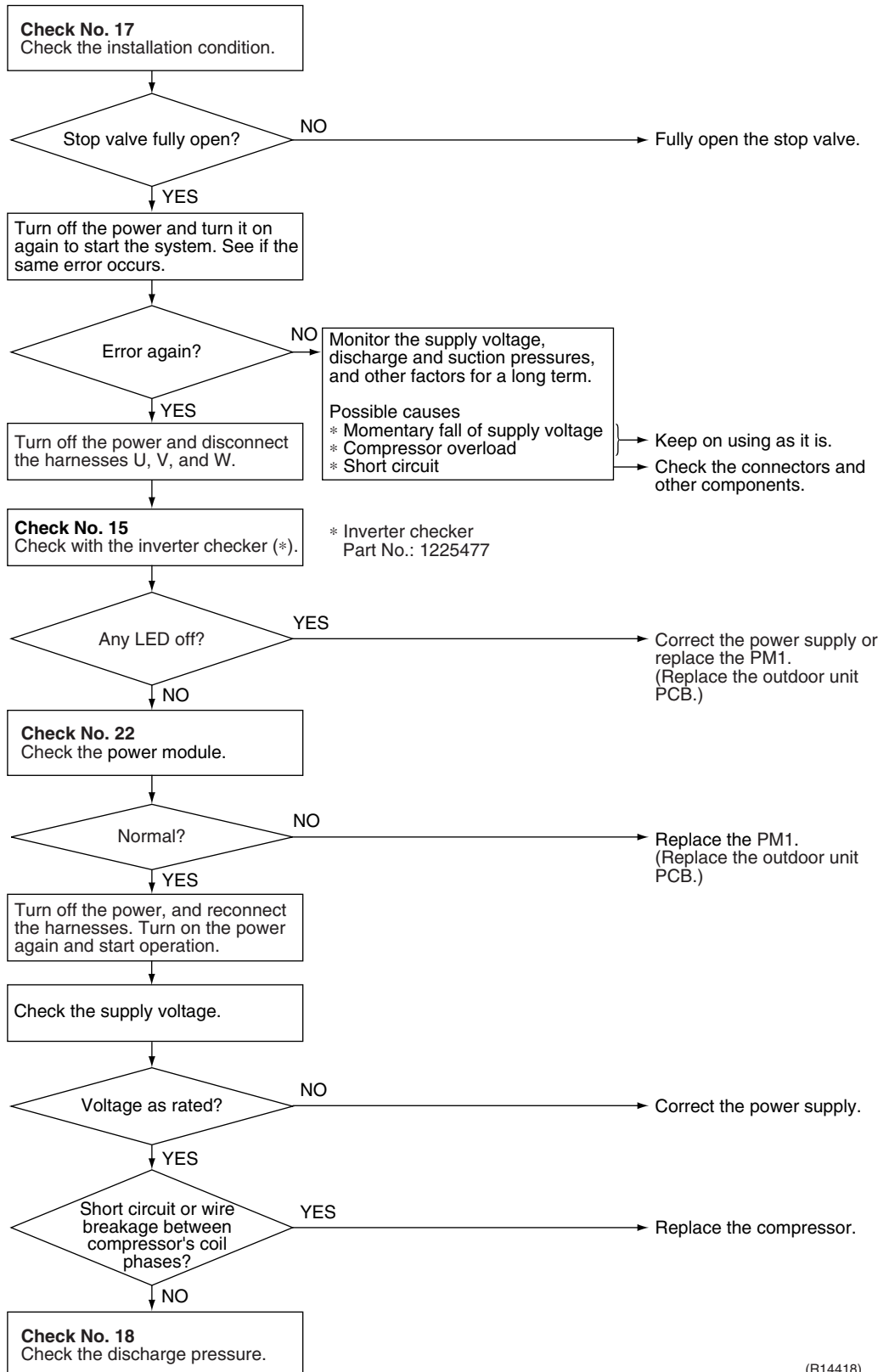

(R14418)

4.23 Refrigerant Shortage

Remote
Controller
Display



Method of
Malfunction
Detection

Refrigerant shortage detection I:

Refrigerant shortage is detected by checking the input current value and the compressor running frequency. If the refrigerant is short, the input current is lower than the normal value.

Refrigerant shortage detection II:

Refrigerant shortage is detected by checking the discharge pipe temperature and the opening of the electronic expansion valve. If the refrigerant is short, the discharge pipe temperature tends to rise.

Refrigerant shortage detection III:

Refrigerant shortage is detected by checking the difference between suction and discharge temperature.

Malfunction
Decision
Conditions

Refrigerant shortage detection I:

The following conditions continue for 7 minutes.

- ◆ Input current $\leq \mathbf{A} \times \text{output frequency} + \mathbf{B}$
- ◆ Output frequency $> \mathbf{C}$

A (-)	B (A)	C (Hz)
27/1000	2.0	40

Refrigerant shortage detection II:

The following conditions continue for 80 seconds.

- ◆ Opening of the electronic expansion valve $\geq \mathbf{D}$
- ◆ Discharge pipe temperature ($^{\circ}\text{C}$) $> \mathbf{E} \times \text{target discharge pipe temperature } (^{\circ}\text{C}) + \mathbf{F} (^{\circ}\text{C})$
(Discharge pipe temperature ($^{\circ}\text{F}$) $> \mathbf{E} \times \text{target discharge pipe temperature } (^{\circ}\text{F}) + \mathbf{G} (^{\circ}\text{F})$)

	D (pulse)	E (-)	F ($^{\circ}\text{C}$)	G ($^{\circ}\text{F}$)
Cooling	480	128/128	50	90
Heating			45	81

- If the error repeats, the system is shut down.
- Reset condition: Continuous run for about 60 minutes without any other error

Supposed
Causes

- Disconnection of discharge pipe thermistor, indoor or outdoor heat exchanger thermistor, room or outdoor temperature thermistor
- Closed stop valve
- Refrigerant shortage (refrigerant leakage)
- Poor compression performance of compressor
- Defective electronic expansion valve

Troubleshooting



Check No.01
Refer to P.110



Check No.12
Refer to P.112



Caution Be sure to turn off the power switch before connecting or disconnecting connectors, or parts may be damaged.

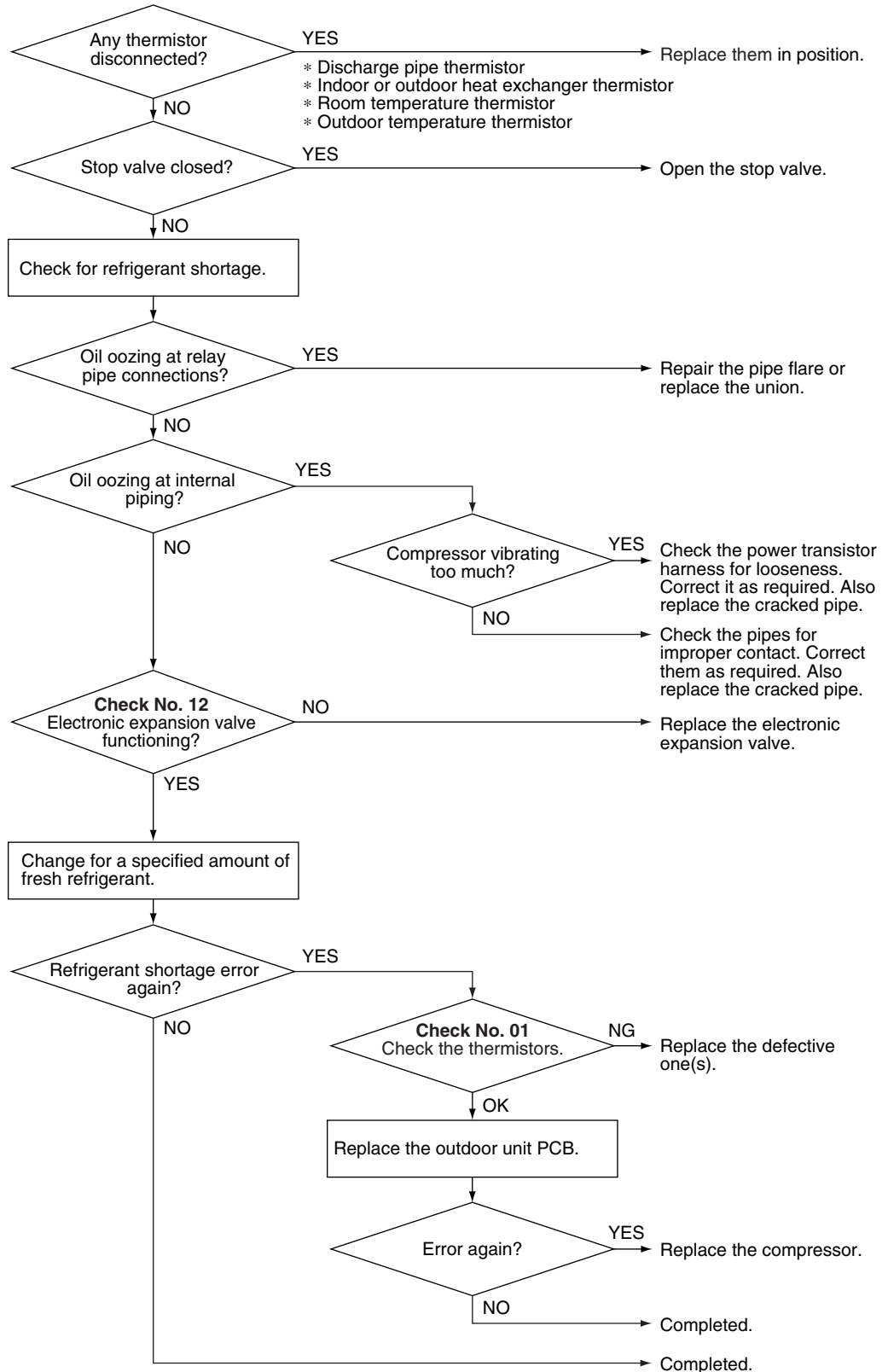

(R14447)

4.24 Low-voltage Detection or Over-voltage Detection

<p>Remote Controller Display</p>	<p>U2</p>
<p>Method of Malfunction Detection</p>	<p>Low-voltage detection: An abnormal voltage drop is detected by the DC voltage detection circuit.</p> <p>Over-voltage detection: An abnormal voltage rise is detected by the over-voltage detection circuit.</p>
<p>Malfunction Decision Conditions</p>	<p>Low-voltage detection:</p> <ul style="list-style-type: none"> ■ The voltage detected by the DC voltage detection circuit is below 150 V. ■ The compressor stops if the error occurs, and restarts automatically after 3-minute standby. <p>Over-voltage detection:</p> <ul style="list-style-type: none"> ■ An over-voltage signal is fed from the over-voltage detection circuit to the microcomputer. ■ The compressor stops if the error occurs, and restarts automatically after 3-minute standby.
<p>Supposed Causes</p>	<ul style="list-style-type: none"> ■ Supply voltage is not as specified. ■ Defective DC voltage detection circuit ■ Defective over-voltage detection circuit ■ Defective PAM control part ■ Layer short inside the fan motor winding

Troubleshooting

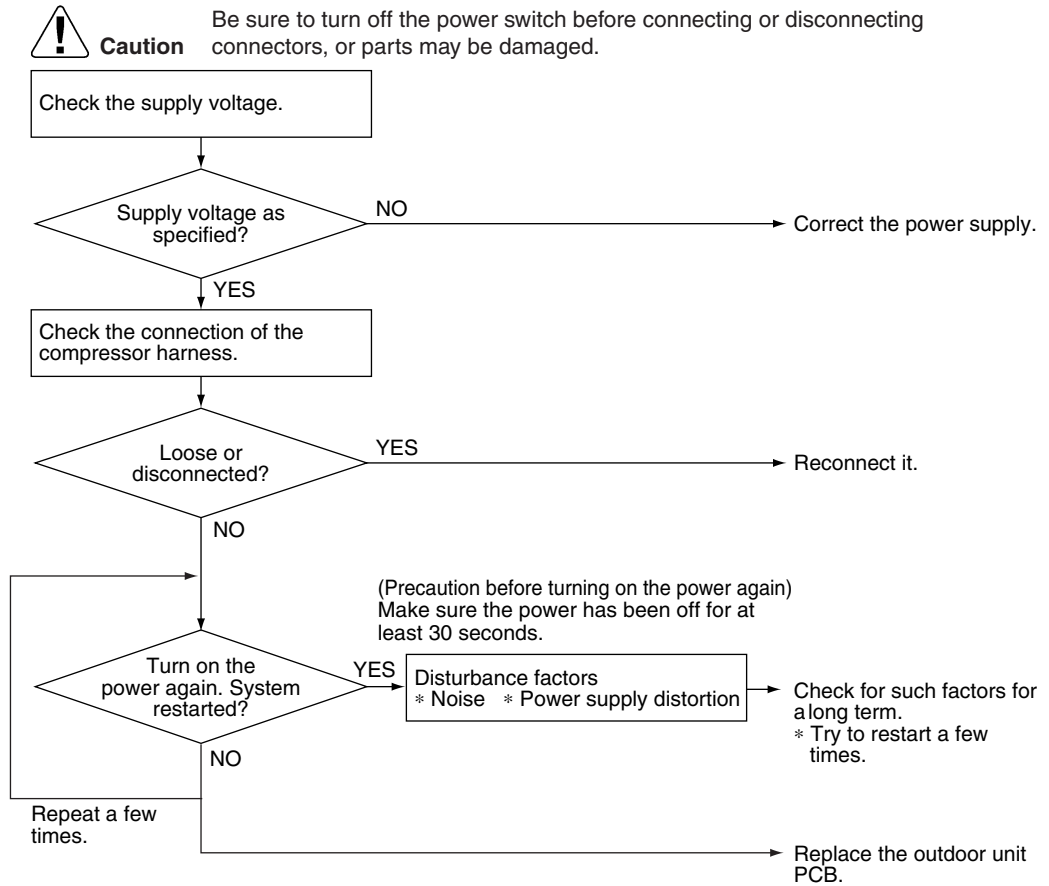

(R14389)

4.25 Signal Transmission Error on Outdoor Unit PCB

Remote
Controller
Display



Method of
Malfunction
Detection

Communication error between microcomputer mounted on the main microcomputer and PM1.

Malfunction
Decision
Conditions

- The abnormality is determined when the data sent from the PM1 can not be received for 9 seconds.
- The error counter is reset when the data from the PM1 can be successfully received.

Supposed
Causes

- Defective outdoor unit PCB

Troubleshooting



Caution

Be sure to turn off the power switch before connecting or disconnecting connectors, or parts may be damaged.

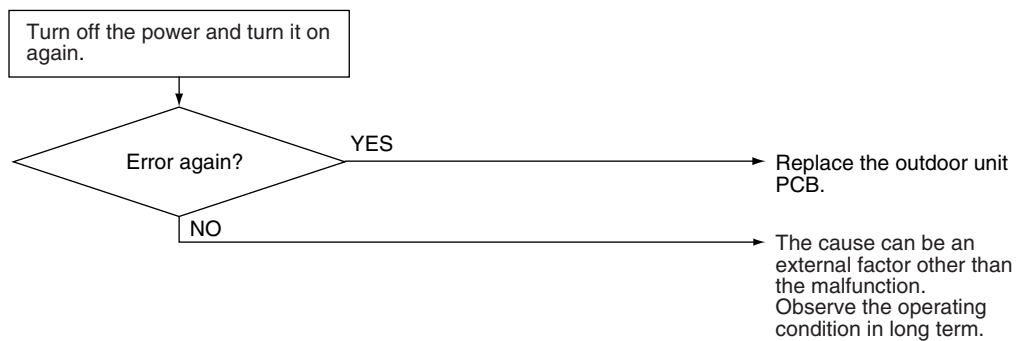

(R7185)

5. Check

5.1 Thermistor Resistance Check

Check No.01

Disconnect the connectors of the thermistors from the PCB, and measure the resistance of each thermistor using tester.

The relationship between normal temperature and resistance is shown in the table and the graph below.

Temperature (°C / °F)	Resistance (kΩ)
-20 / -4	211.0
-15 / 5	150.0
-10 / 14	116.5
-5 / 23	88.0
0 / 32	67.2
5 / 41	51.9
10 / 50	40.0
15 / 59	31.8
20 / 68	25.0
25 / 77	20.0
30 / 86	16.0
35 / 95	13.0
40 / 104	10.6
45 / 113	8.7
50 / 122	7.2

(R25°C (77°F) = 20 kΩ, B = 3950 K)

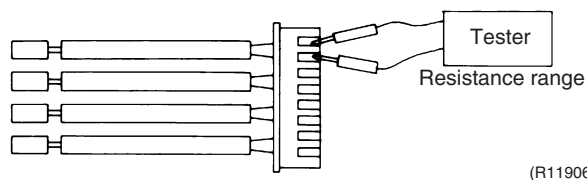
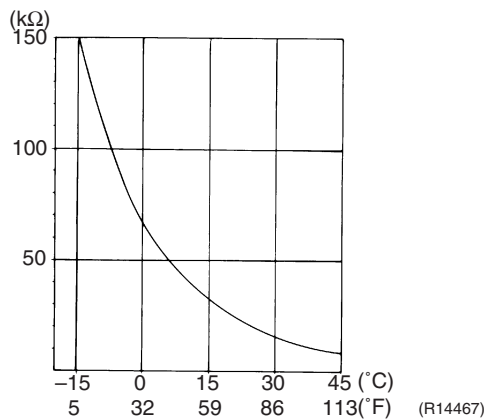

- For the models in which the thermistor is directly mounted on the PCB, disconnect the connector for the PCB and measure.

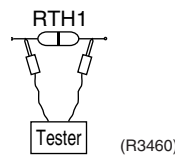

5.2 Fan Motor Connector Output Check

Check No.02

1. Check the connection of connector.
2. Check the motor power supply voltage output (pins 4 - 7).
3. Check the motor control voltage (pins 4 - 3).
4. Check the rotation command voltage (pins 4 - 2).
5. Check the rotation pulse (pins 4 - 1).

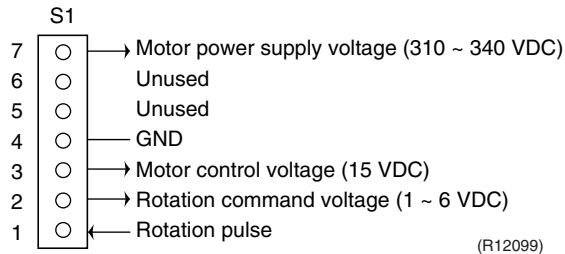

5.3 Power Supply Waveforms Check

Check No.11

Measure the power supply waveform between No. 1 and No. 2 on the terminal board, and check the waveform disturbance.

- Check to see if the power supply waveform is a sine wave. (Fig.1)
- Check to see if there is waveform disturbance near the zero cross. (sections circled in Fig.2)

Fig.1

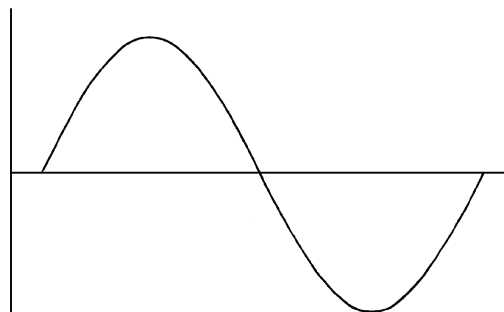
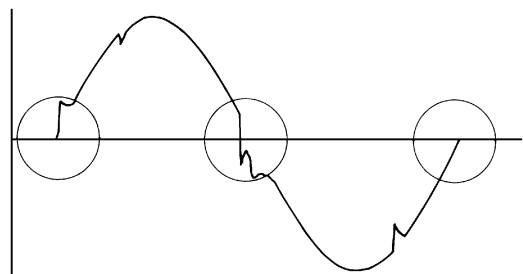

Fig.2



5.4 Electronic Expansion Valve Check

Check No.12

Conduct the followings to check the electronic expansion valve (EV).

1. Check to see if the EV connector is correctly connected to the PCB.
2. Turn the power off and on again, and check to see if the EV generate latching sound.
3. If the EV does not generate latching sound in the above step 2, disconnect the connector and check the continuity using a tester.
4. Check the continuity between the pins 1 - 6 and 3 - 6, and between the pins 2 - 5 and 4 - 5. If there is no continuity between the pins, the EV coil is faulty.

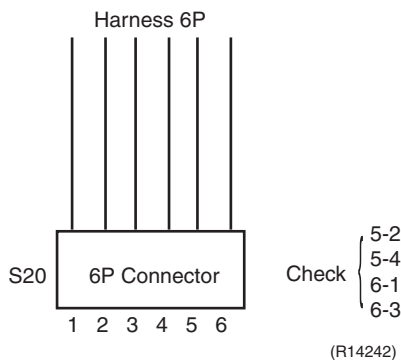

5. If the continuity is confirmed in the above step 3, the outdoor unit PCB is faulty.



Note: Please note that the latching sound varies depending on the valve type.

5.5 Four-Way Valve Performance Check

Check No.13

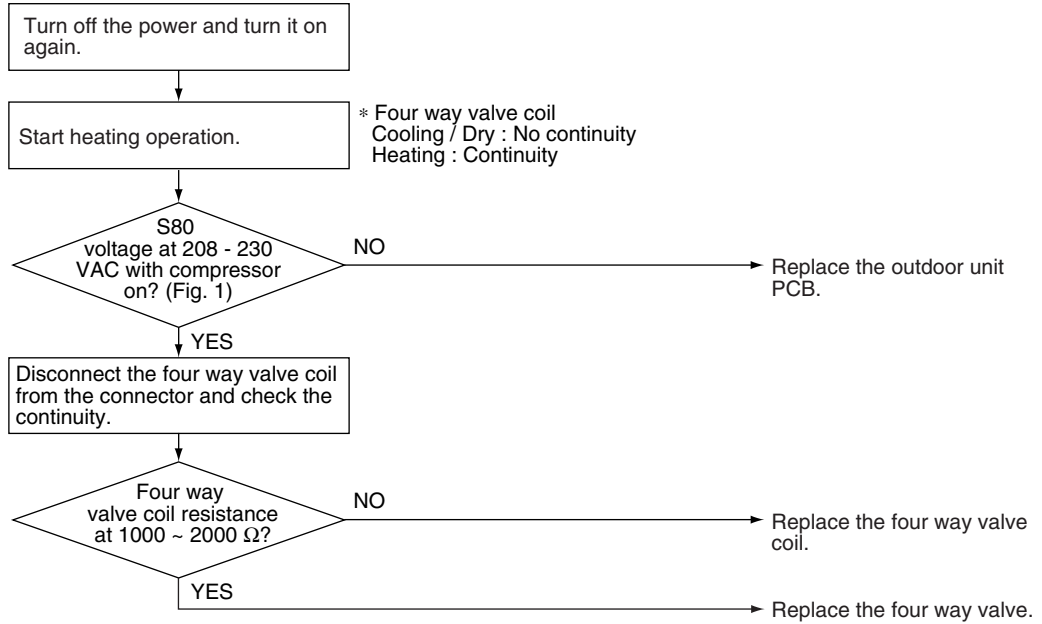

(R14715)

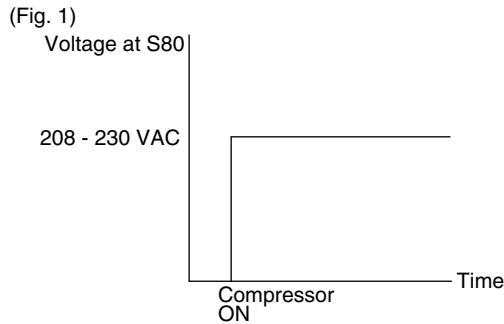

(R14716)

5.6 Inverter Unit Refrigerant System Check

Check No.14

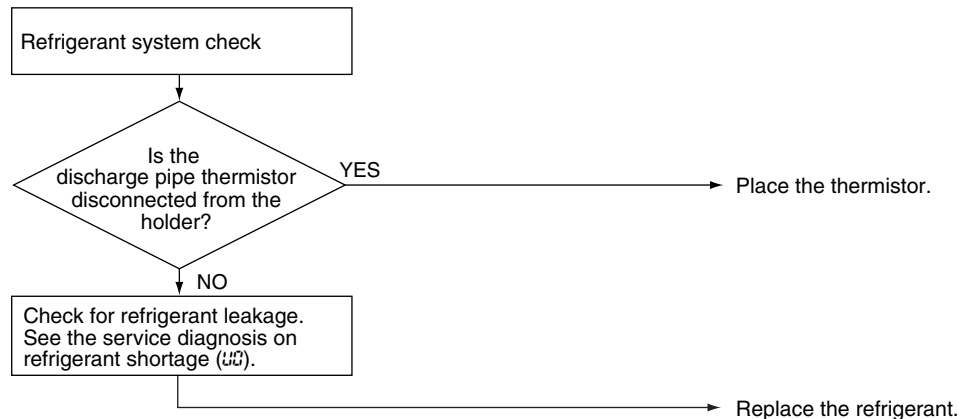

(R8259)

5.7 “Inverter Checker” Check

Check No.15

■ Characteristics

If abnormal stop occurs due to compressor startup failure or overcurrent output when using inverter unit, it is difficult to judge whether it is caused by the compressor failure or other failure (control PCB, power module, etc.). The inverter checker makes it possible to judge the cause of trouble easily and securely. (Connect this checker as a quasi-compressor instead of compressor and check the output of inverter)

■ Operation Method

Step 1

Be sure to turn the power off.

Step 2

Install the inverter checker instead of a compressor.

Note:

Make sure the charged voltage of the built-in smoothing electrolytic capacitor drops to 10 VDC or below before carrying out the service work.

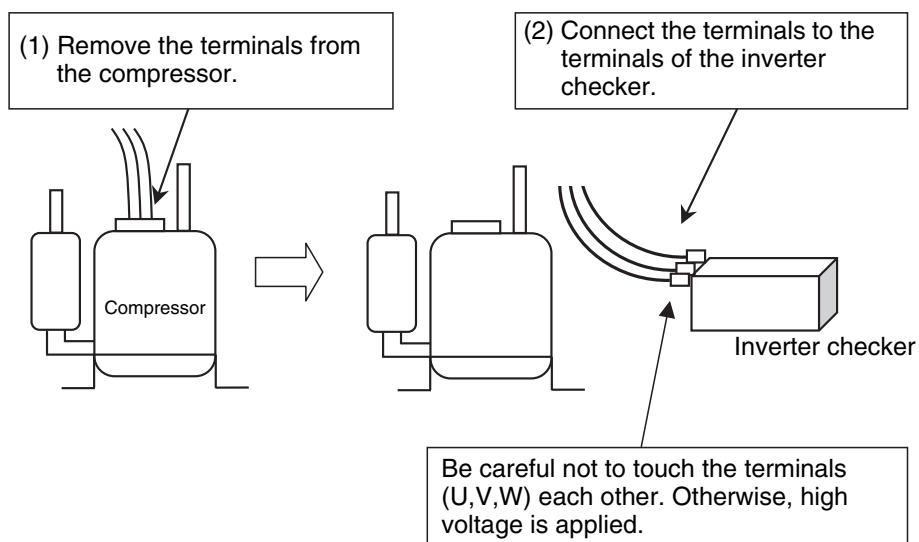

(R13940)

Reference:

If the terminals of the compressor are not FASTON terminals (difficult to remove the wire on the terminals), it is possible to connect wires available on site to the outdoor unit from output side of PCB. (Do not connect them to the compressor at the same time, otherwise it may result in incorrect detection.)

Step 3

Activate power transistor test operation from the outdoor unit.

- 1) Press the forced cooling operation ON/OFF button for 5 seconds.
(Refer to page 183 for the position.)
→ Power transistor test operation starts.

■ **Diagnose method (Diagnose according to 6 LEDs lighting status.)**

- (1) When all the LEDs are lit uniformly, the compressor is defective.
→ Replace the compressor.
- (2) When the LEDs are not lit uniformly, check the power module.
→ Refer to **Check No.13**.
- (3) If NG in **Check No.13**, replace the power module (control PCB).
If OK in **Check No.13**, check if there is any solder cracking on the filter PCB.
- (4) If any solder cracking is found, replace the filter PCB or repair the soldered section.
If the filter PCB is OK, replace the control PCB.



Caution

- (1) When the output frequency is low, the LEDs blink slowly. As the output frequency increases, the LEDs blink quicker. (The LEDs look like they are lit.)
- (2) On completion of diagnose by the inverter checker, be sure to re-crimp the FASTON terminals. Otherwise, the terminals may be burned due to loosening.

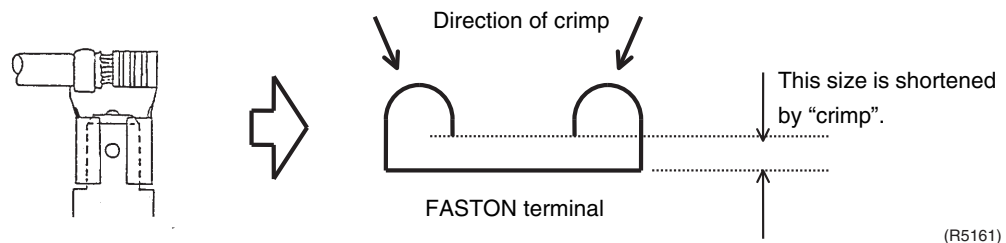

5.8 Rotation Pulse Check on the Outdoor Unit PCB

Check No.16

Make sure that the voltage of 320 ± 30 V is applied.

1. Set operation off and power off. Disconnect the connector S70.
2. Check that the voltage between the pins 4 - 7 is 320 VDC.
3. Check that the control voltage between the pins 3 - 4 is 15 VDC.
4. Check that the rotation command voltage between the pins 2 - 4 is 0 ~ 15 VDC.
5. Keep operation off and power off. Connect the connector S70.
6. Check whether 2 pulses (0 ~ 15 VDC) are output at the pins 1 - 4 when the fan motor is rotated 1 turn by hand.

When the fuse is melted, check the outdoor fan motor for proper function.

If NG in step 2 → Defective PCB → Replace the outdoor unit PCB.

If NG in step 4 → Defective Hall IC → Replace the outdoor fan motor.

If OK in both steps 2 and 4 → Replace the outdoor unit PCB.

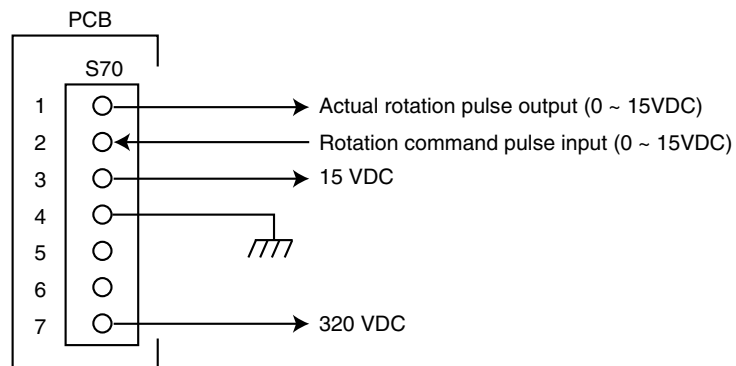

(R10811)

5.9 Installation Condition Check

Check No.17

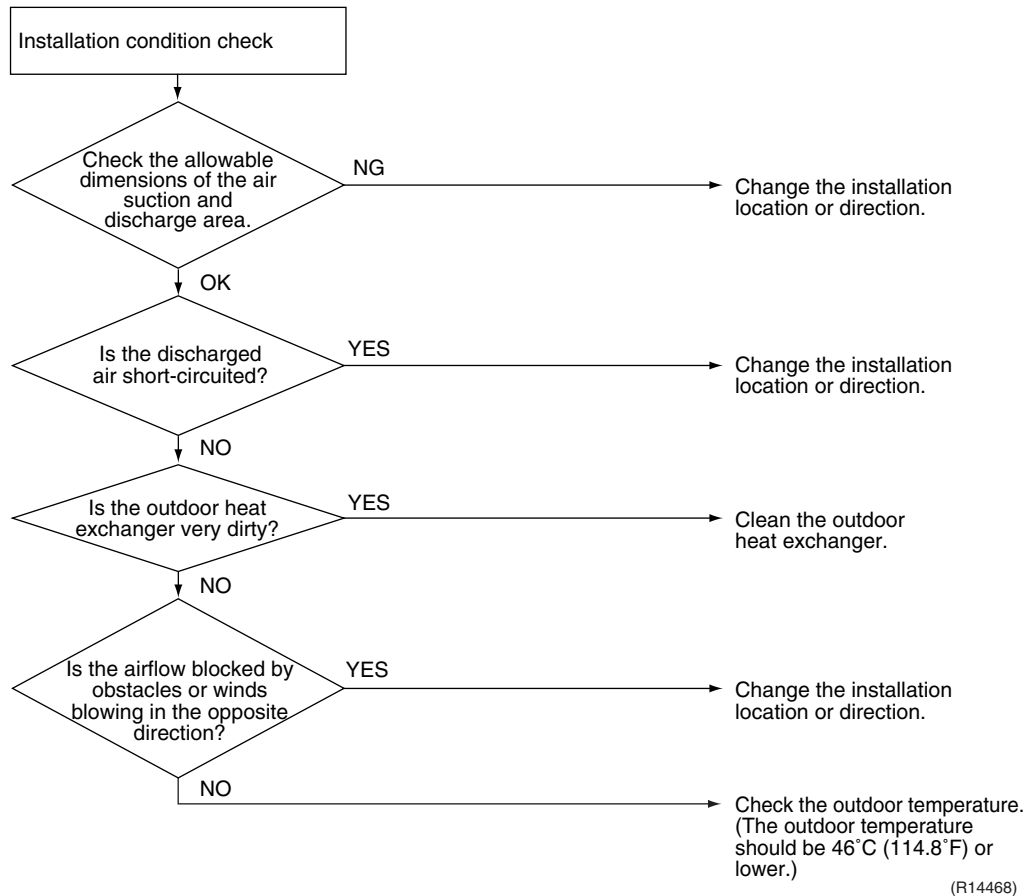

5.10 Discharge Pressure Check

Check No.18

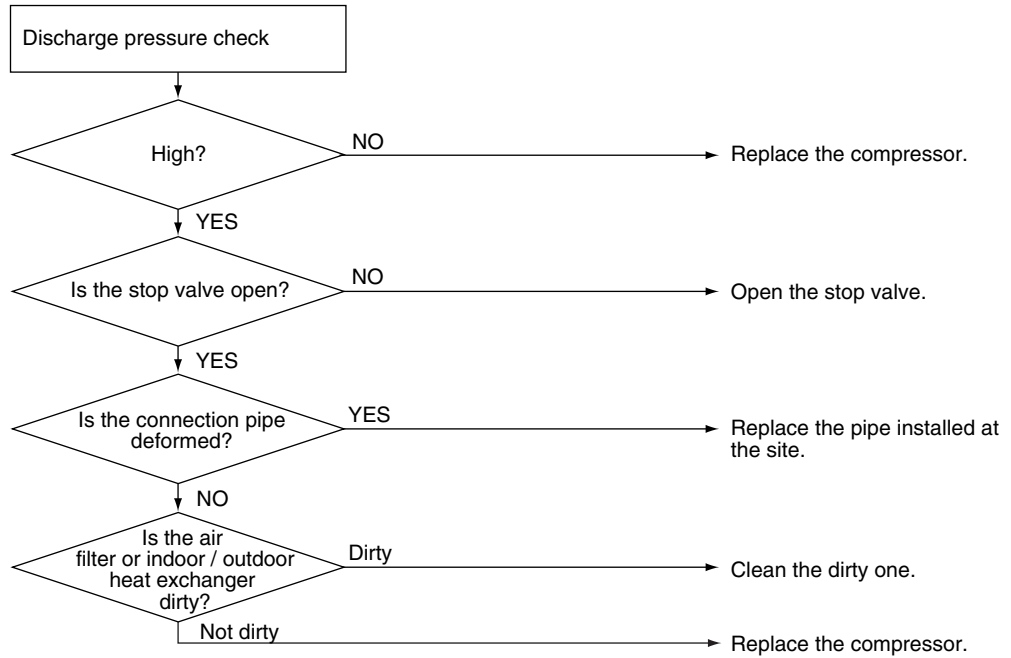

(R11718)

5.11 Outdoor Fan System Check

Check No.19

DC motor

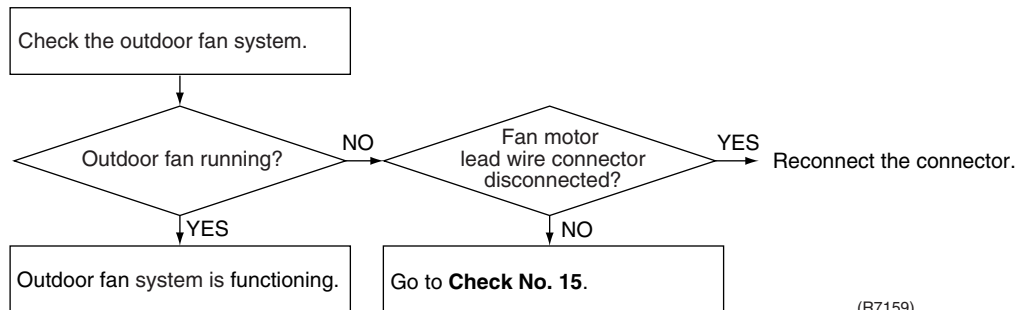

(R7159)

5.12 Capacitor Voltage Check

Check No.21

Before this check, be sure to check the main circuit for short circuit.
 With the circuit breaker still on, measure the voltage according to the drawing of the model in question. Be careful never to touch any live parts.

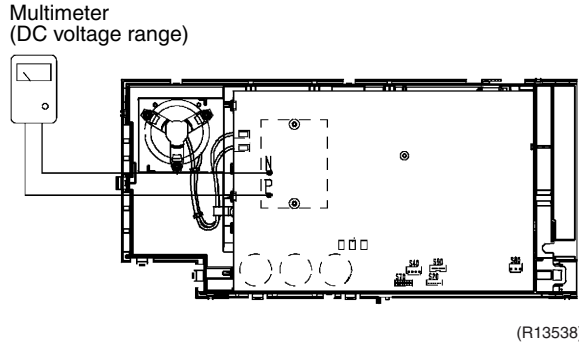

5.13 Power Module Check

Check No.22



Note: Check to make sure that the voltage between (+) and (-) of the diode bridge (DB1) is approx. 0 V before checking.

- Disconnect the compressor harness connector from the outdoor unit PCB. To disengage the connector, press the protrusion on the connector.
- Follow the procedure below to measure resistance between the terminals of the DB1 and the terminals of the compressor with a multi-tester. Evaluate the measurement results for a judgment.

Negative (-) terminal of tester (positive terminal (+) for digital tester)	DB1 (+)	UVW	DB1 (-)	UVW
Positive (+) terminal of tester (negative terminal (-) for digital tester)	UVW	DB1 (+)	UVW	DB1 (-)
Resistance is OK	several kΩ ~ several MΩ			
Resistance is NG	0 Ω or ∞			

Part 7

Removal Procedure

1. Indoor Unit.....	121
1.1 Removal of Air Filters / Front Panel	121
1.2 Removal of Front Grille	124
1.3 Removal of Electrical Box	127
1.4 Removal of PCBs	133
1.5 Removal of Horizontal Blades / Vertical Blades / Swing Motors	140
1.6 Removal of Fan Motor.....	148
1.7 Removal of Indoor Heat Exchanger	151
1.8 Removal of Fan Rotor	154
2. Outdoor Unit.....	156
2.1 Removal of Outer Panels	156
2.2 Removal of Electrical Box	166
2.3 Removal of PCBs	170
2.4 Removal of Fan Motor.....	173
2.5 Removal of Coils / Thermistors	174
2.6 Removal of Sound Blankets	177
2.7 Removal of Compressor.....	179

1. Indoor Unit

1.1 Removal of Air Filters / Front Panel

Procedure



Warning Be sure to wait for 10 minutes or more after turning off all power supplies before disassembling work.

Step	Procedure	Points
<p>1. Features</p>		<p>Warning Dangerous: High voltage A high voltage is applied to all the electric circuits of this product including thermistors.</p> <ul style="list-style-type: none"> ■ When the signal receiver catches a signal from the remote controller, the receiving tone sounds and the operation lamp blinks immediately to confirm the signal reception. ■ When the ON/OFF button is kept pressed for 5 seconds, the forced cooling operation is performed for about 15 minutes.
<p>2. Remove the air filters.</p> <p>1 Open the front panel to the position where it stops.</p> <p>2 Slightly push up the center knob of the air filter and unfasten the hooks.</p> <p>3 Pull out the air filter downward and remove it.</p>		<ul style="list-style-type: none"> ■ The 3 filters are interchangeable. ■ The air filter can be set easily by inserting it along the guides. ■ Insert the air filter with the "FRONT" mark faced up. ■ Be sure to insert the hooks (at 2 lower positions) when reassembling the air filter.

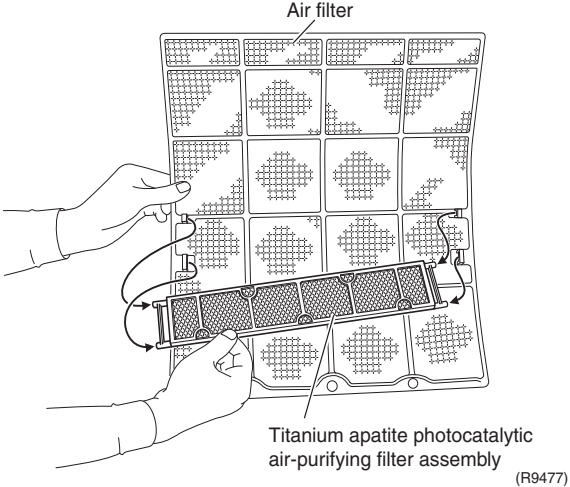
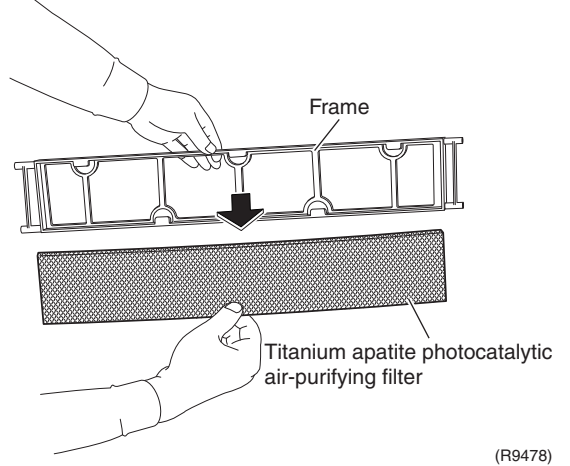
Step	Procedure	Points
3.	Remove the Titanium apatite photocatalytic air-purifying filters.	
1	<p>Remove the Titanium apatite photocatalytic air-purifying filter assembly by unfastening the projections from the back of the air filter frame.</p> 	<ul style="list-style-type: none"> ■ The 3 filters are interchangeable.
2	<p>Remove the Titanium apatite photocatalytic air-purifying filter from its frame.</p> 	

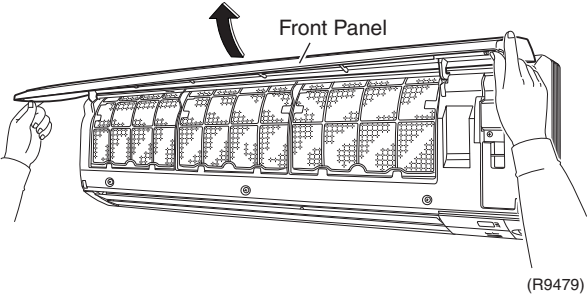
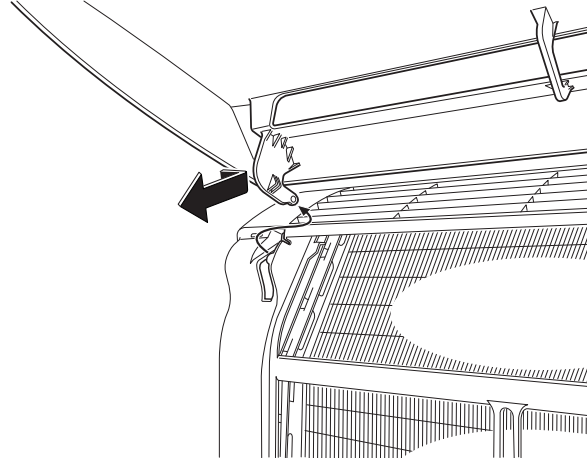
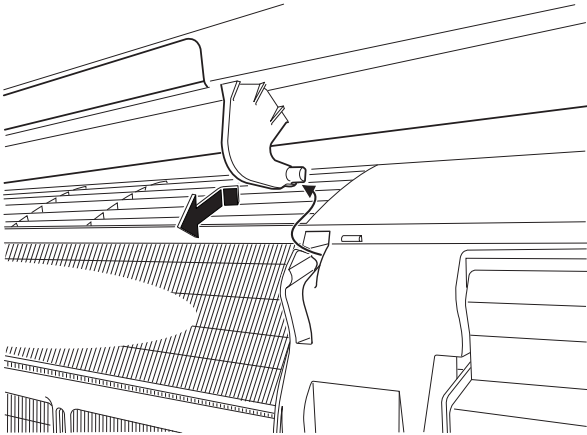
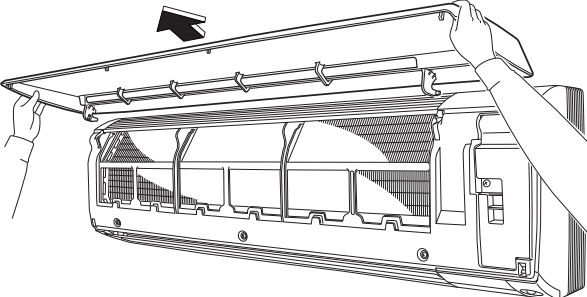
Step	Procedure	Points
<p>4. Remove the front panel.</p> <p>1</p>	 <p>(R9479)</p>  <p>(R9480)</p>  <p>(R9481)</p>	<ul style="list-style-type: none"> ■ Slide the front panel from side to side to release each shaft. ■ Align the right and left shafts with grooves in turn and insert them to the end when reassembling.
<p>2</p>	<p>Remove the front panel.</p>  <p>(R9482)</p>	

1.2 Removal of Front Grille

Procedure

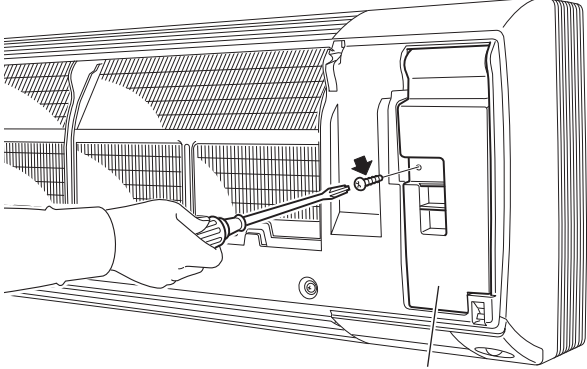
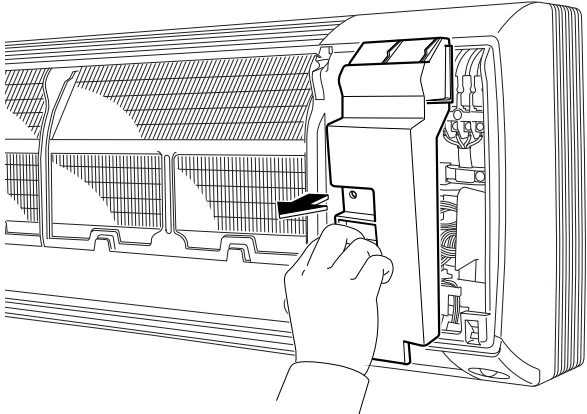
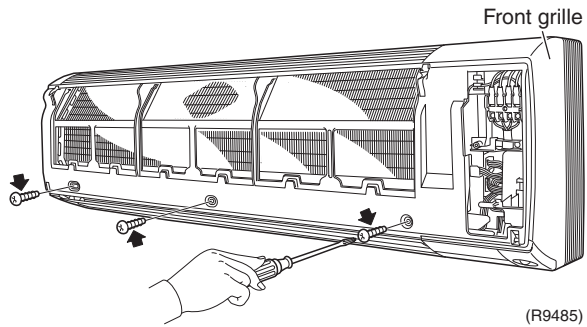
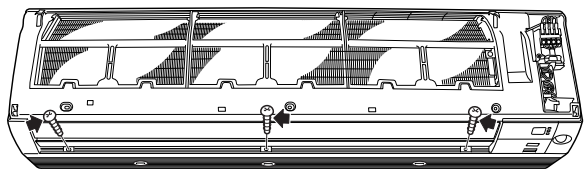

Warning Be sure to wait for 10 minutes or more after turning off all power supplies before disassembling work.

Step	Procedure	Points
<p>1. Remove the service cover.</p> <p>1 Remove the screw and remove the service cover.</p>	 <p>Service cover (R9483)</p>  <p>(R9484)</p>	<ul style="list-style-type: none"> ■ You can remove the front grille without detaching the service cover.
<p>2. Remove the front grille.</p> <p>1 Remove the 3 screws of the front grille.</p> <p>2 Remove the lower 3 screws.</p>	 <p>Front grille</p> <p>(R9485)</p>  <p>(R9488)</p>	<ul style="list-style-type: none"> ■ Refer to the removal procedure in a reverse way when reassembling.

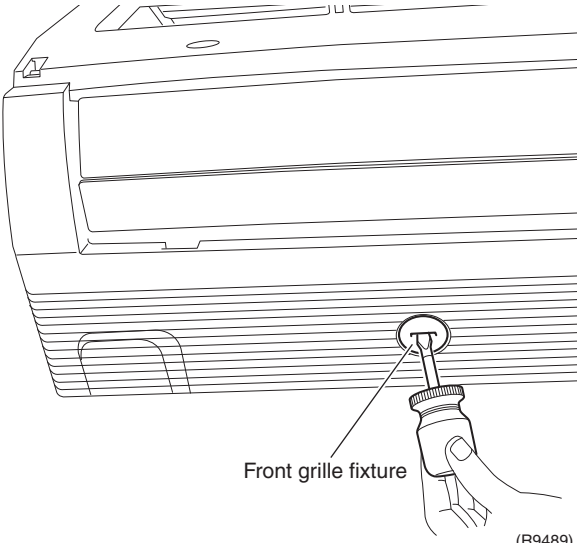
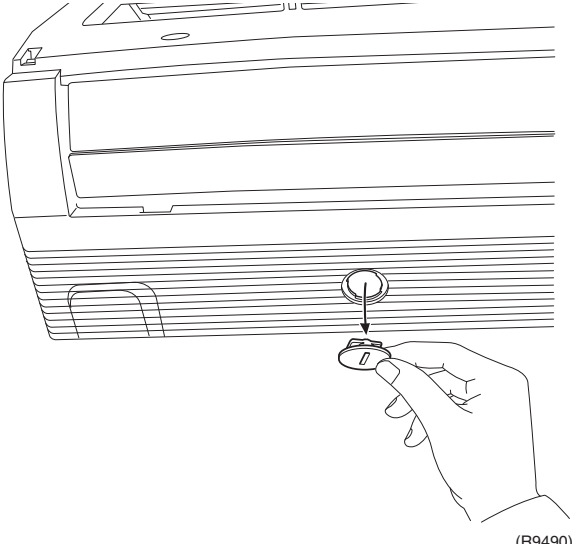
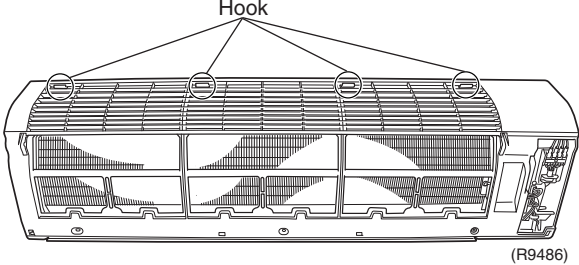
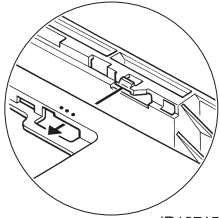
Step		Procedure	Points
3	Remove the 3 front grille fixtures.	 <p>Front grille fixture</p> <p>(R9489)</p>  <p>(R9490)</p>	<ul style="list-style-type: none"> ■ The illustration shows the left fixture.
4	Unfasten the 4 hooks on the top of the front grille.	 <p>Hook</p> <p>(R9486)</p>	<ul style="list-style-type: none"> ■ The convex marks (...) on the front panel indicate the position of the hooks.  <p>(R12715)</p>

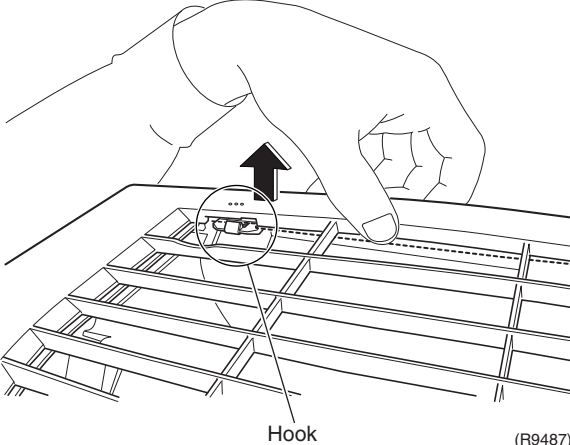
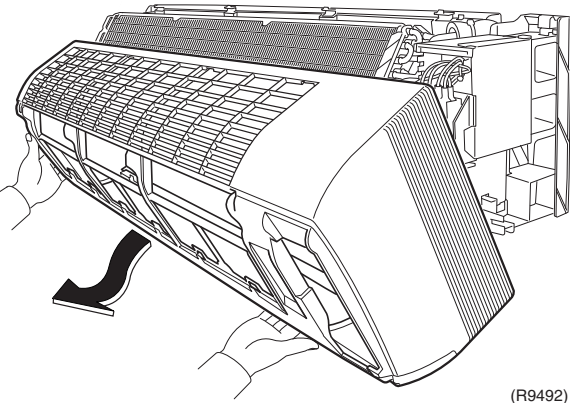

Step	Procedure	Points
5	<p data-bbox="196 730 446 892">Pull the upper part of the front grille out and lift the lower part up, and then remove the front grille.</p>  <p data-bbox="760 682 812 703">Hook</p> <p data-bbox="1003 688 1063 709">(R9487)</p>  <p data-bbox="1003 1171 1063 1192">(R9492)</p>	<ul style="list-style-type: none"> <li data-bbox="1088 730 1485 829">■ When reassembling, make sure that all the 4 hooks are fastened as they were.

1.3 Removal of Electrical Box

Procedure

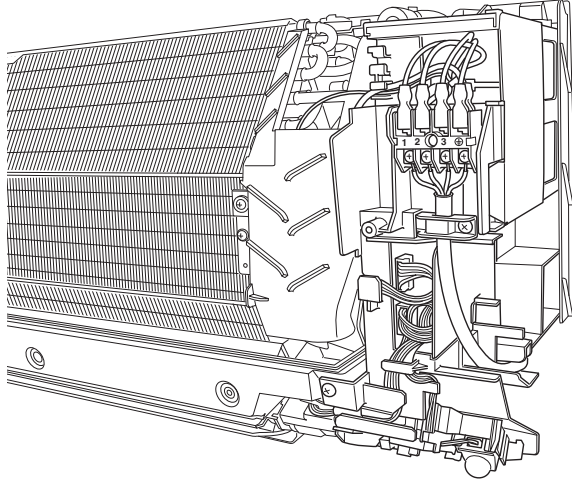
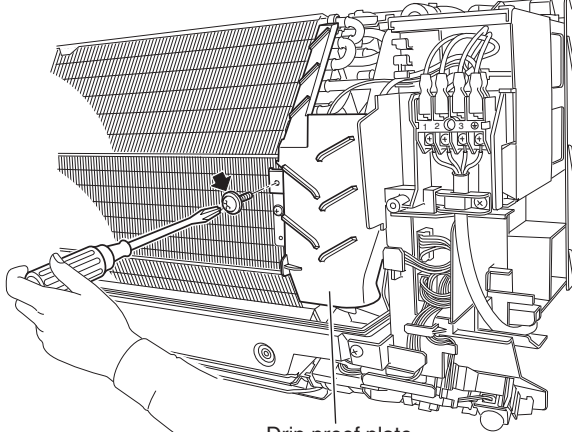
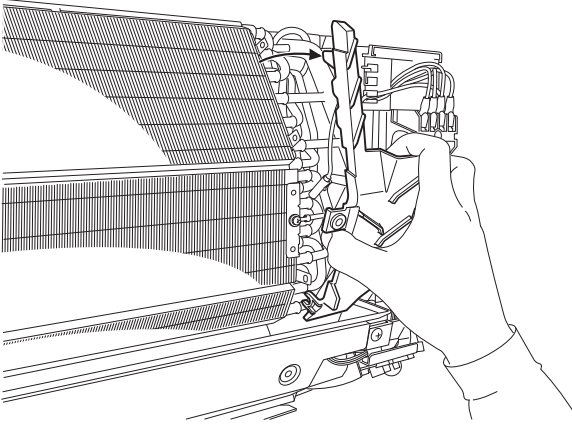

Warning Be sure to wait for 10 minutes or more after turning off all power supplies before disassembling work.

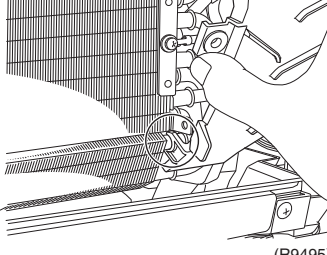
Step	Procedure	Points
1. Layout of the parts	 <p style="text-align: right;">(R9493)</p>	<p>Preparation</p> <ul style="list-style-type: none"> Remove the front grille according to the "Removal of Front Grille."
2. Remove the drip proof plate.	 <p style="text-align: center;">Drip proof plate (R9494)</p>	
1 Remove the screw. 2 Remove the drip proof plate from the indoor heat exchanger.	 <p style="text-align: right;">(R9495)</p>  <p style="text-align: right;">(R9496)</p>	 <p style="text-align: right;">(R9495)</p> <ul style="list-style-type: none"> When reassembling, fit the hook to the indoor heat exchanger.

Step	Procedure	Points
3.	Release the grounding and the indoor heat exchanger thermistor.	
1	Remove the screw and release the ground wire.	
2	Pull out the indoor heat exchanger thermistor.	<ul style="list-style-type: none"> ■ Be careful not to lose the clip of the thermistor.
4.	Remove the electrical box.	
1	Disconnect the 4 connection wires on the terminal board. Remove the screw and remove the wire retainer.	<ul style="list-style-type: none"> ■ You can remove the electrical box without detaching the terminal board.

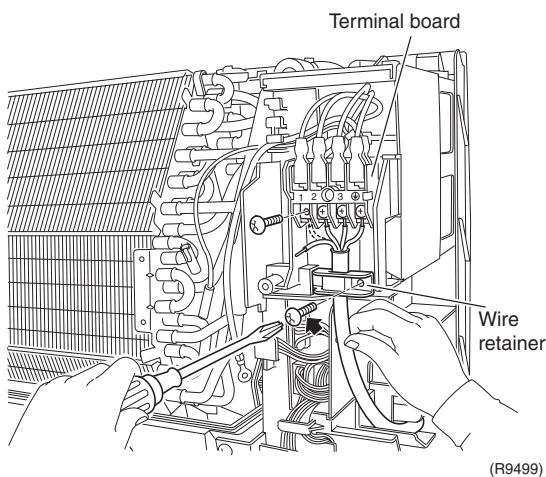
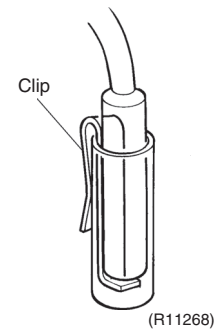
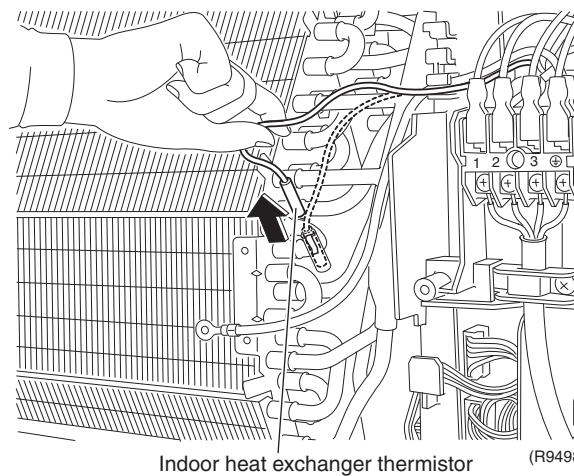
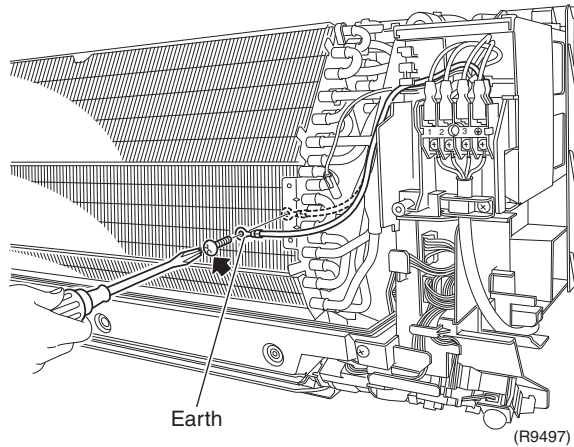

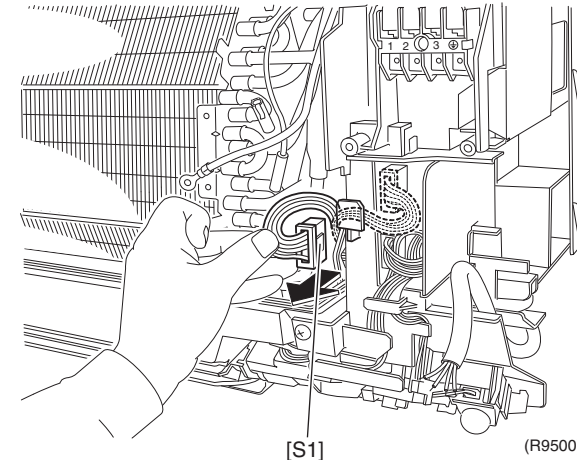
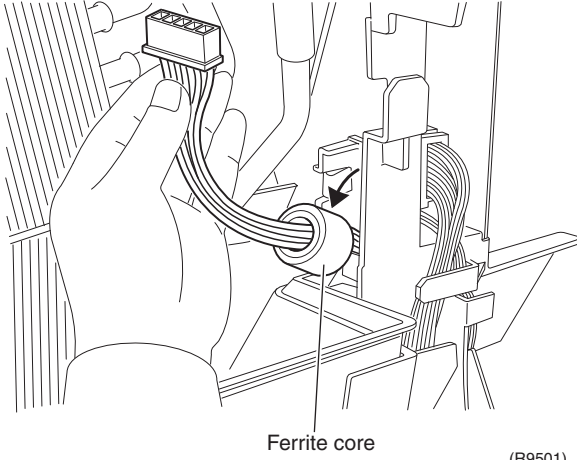
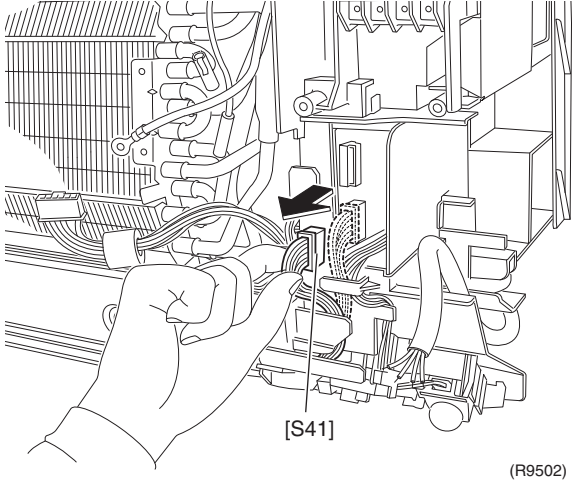
Step	Procedure	Procedure	Points
2	Disconnect the connector for the fan motor [S1] and release the harness from the hook.	 <p>[S1] (R9500)</p>	
3	Release the ferrite core.	 <p>Ferrite core (R9501)</p>	
4	Disconnect the connector for the swing motors [S41].	 <p>[S41] (R9502)</p>	

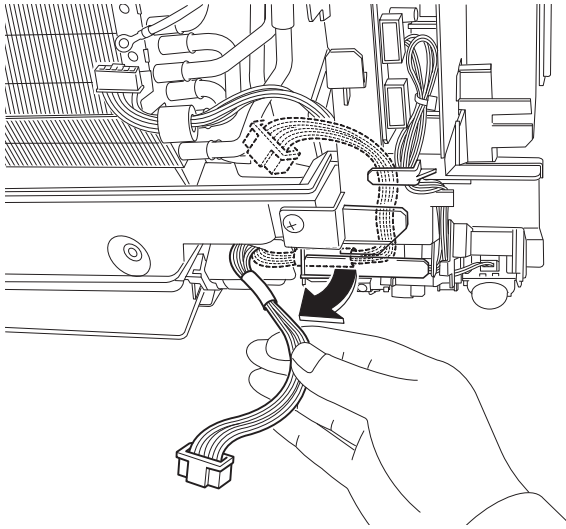
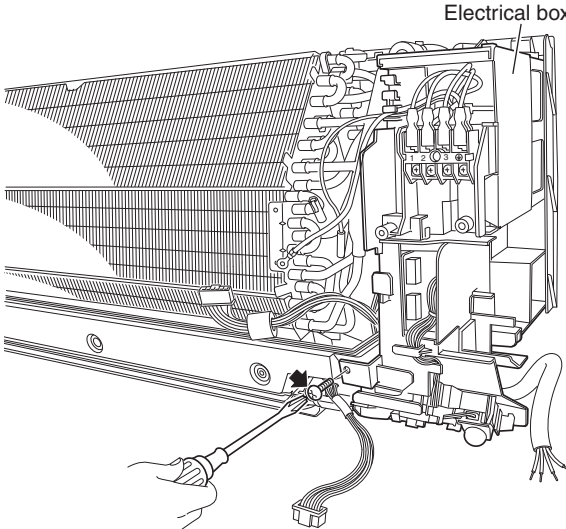
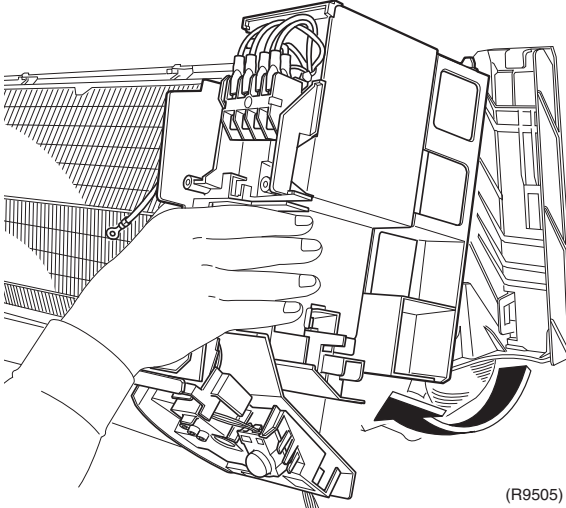
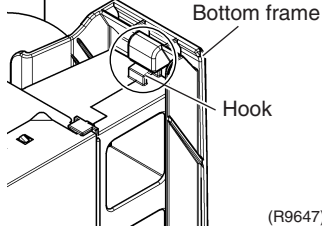
Step	Procedure	Procedure	Points
5	Release the harness from the hooks.	 <p>(R9503)</p>	
6	Remove the screw of the electrical box.	 <p>(R9504)</p>	
7	Lift up the electrical box from the bottom frame and remove it.	 <p>(R9505)</p>	<p>■ Fit the back hook of the electrical box to the bottom frame when reassembling.</p>  <p>(R9647)</p>

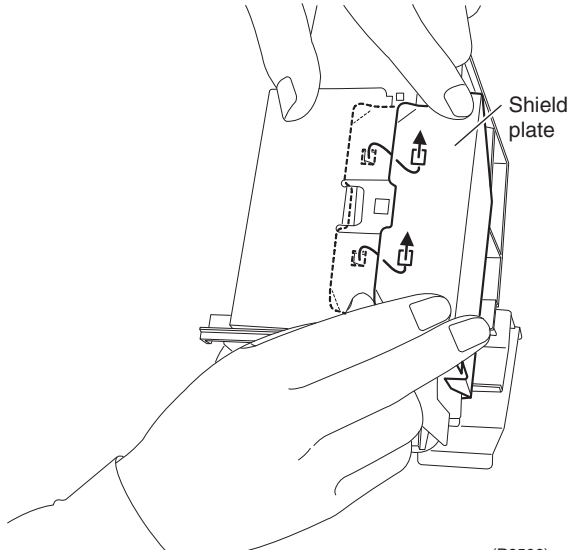
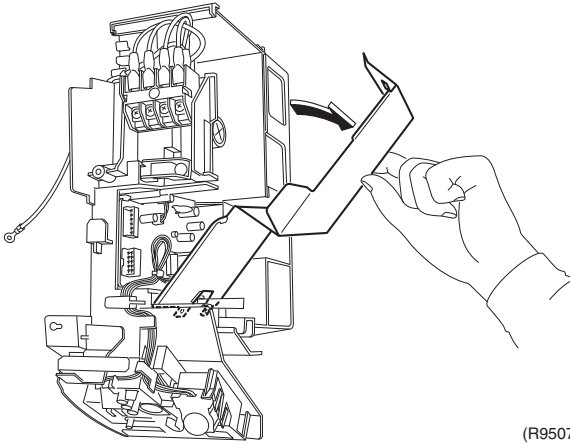
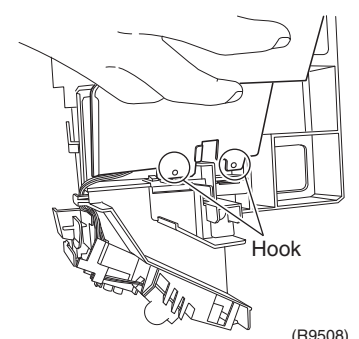
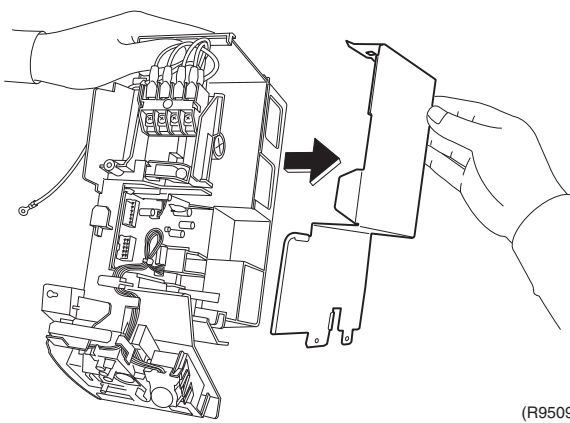
Step	Procedure	Procedure	Points
8	Unfasten the hooks of the shield plate.	 <p>(R9506)</p>	
9	Open the shield plate.	 <p>(R9507)</p>	<p>■ The shield plate has 2 hooks at the lower part also.</p>  <p>(R9508)</p>
10	Remove the shield plate.	 <p>(R9509)</p>	

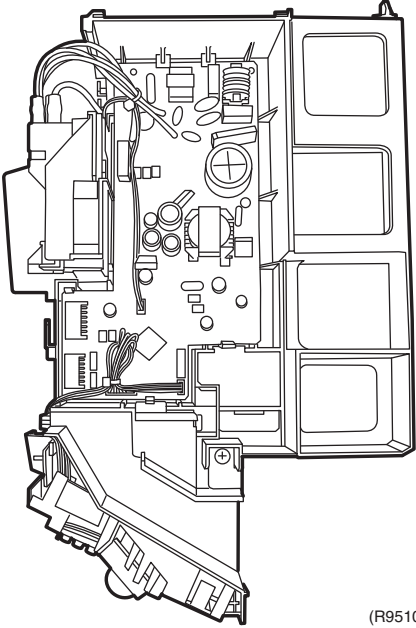
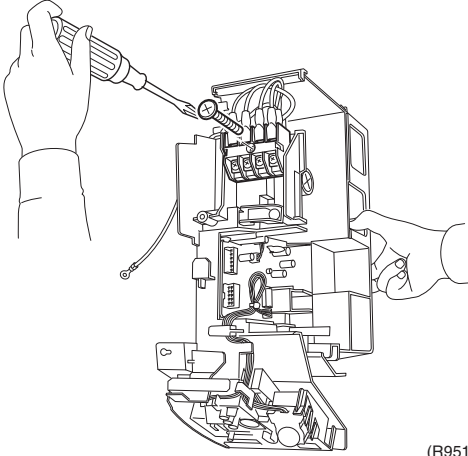
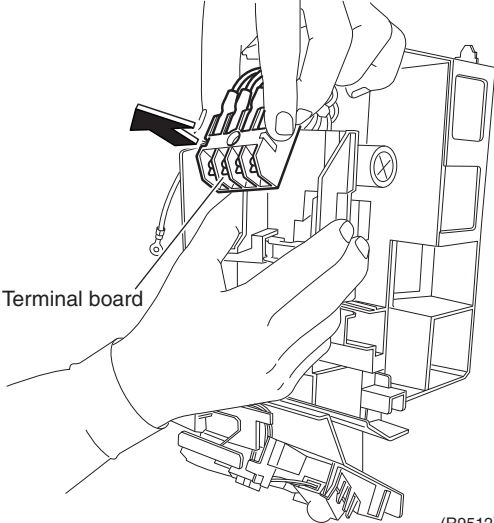
Step	Procedure	Procedure	Points
11	Internal layout	 <p>(R9510)</p>	
12	Remove the screw of the terminal board.	 <p>(R9511)</p>	
13	Remove the terminal board. (1 hook at the back)	 <p>Terminal board</p> <p>(R9512)</p>	

1.4 Removal of PCBs

Procedure

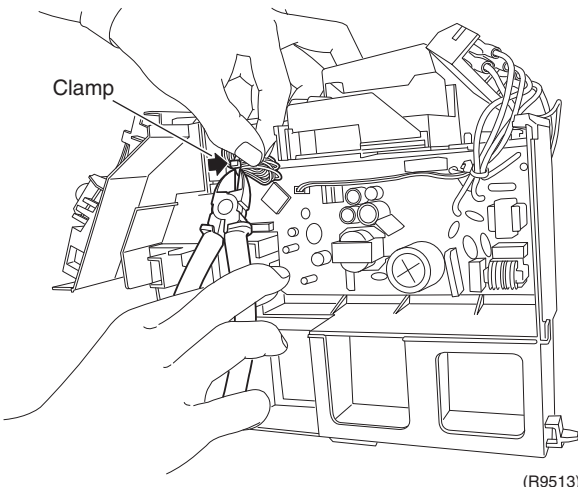
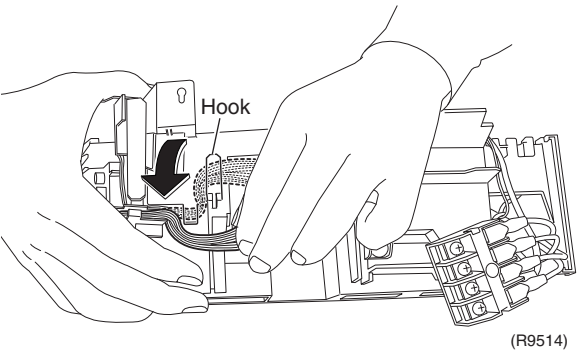
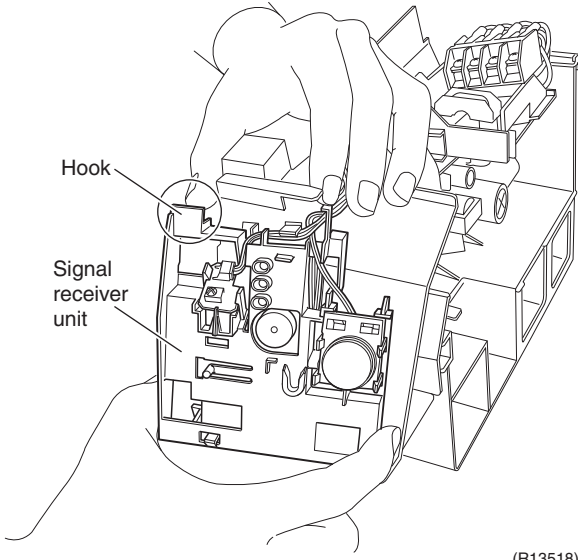

Warning Be sure to wait for 10 minutes or more after turning off all power supplies before disassembling work.

Step	Procedure	Points
1. Remove the signal receiver PCB.		
1 Cut the clamp.	 <p>(R9513)</p>	
2 Release the harness from the hook.	 <p>(R9514)</p>	<ul style="list-style-type: none"> ■ When reassembling, make sure to hook the harness.
3 Push and unfasten the hook of the signal receiver unit.	 <p>(R13518)</p>	

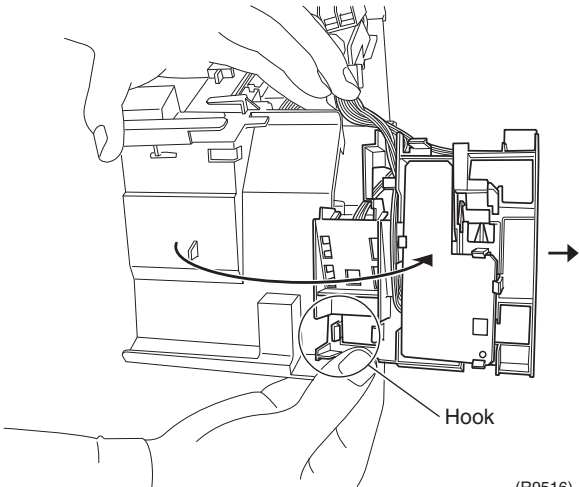
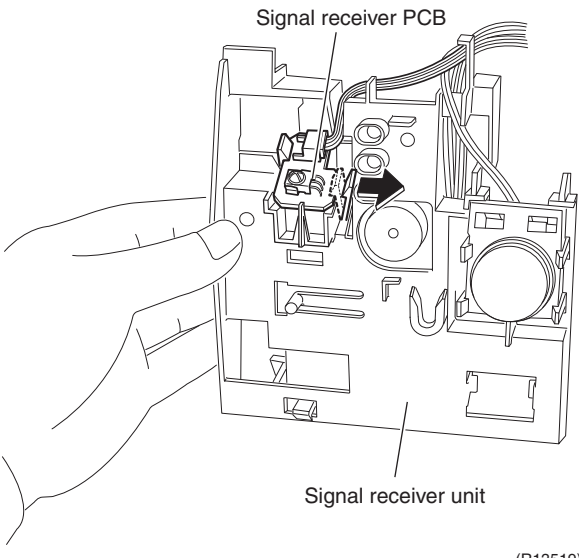
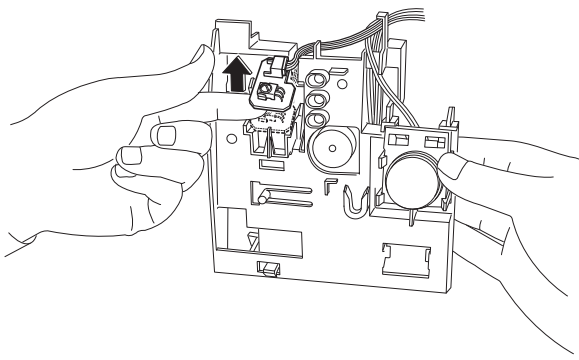
Step	Procedure	Procedure	Points
4	Open the signal receiver unit. Unfasten the hook and remove the signal receiver unit.	 <p style="text-align: right;">(R9516)</p>	
5	Unfasten the hook on the right of the signal receiver PCB. (Then the signal receiver PCB is lifted up.)	 <p style="text-align: right;">(R13519)</p>	
6	Remove the signal receiver PCB.	 <p style="text-align: right;">(R9521)</p>	

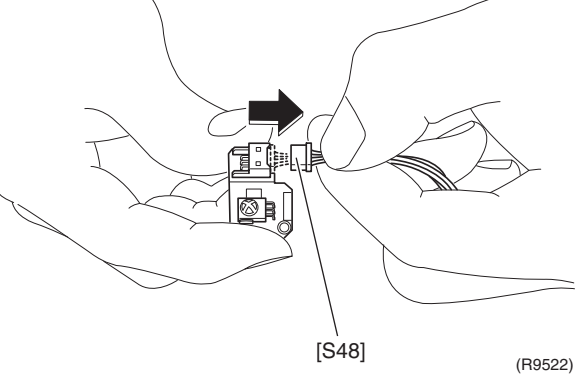
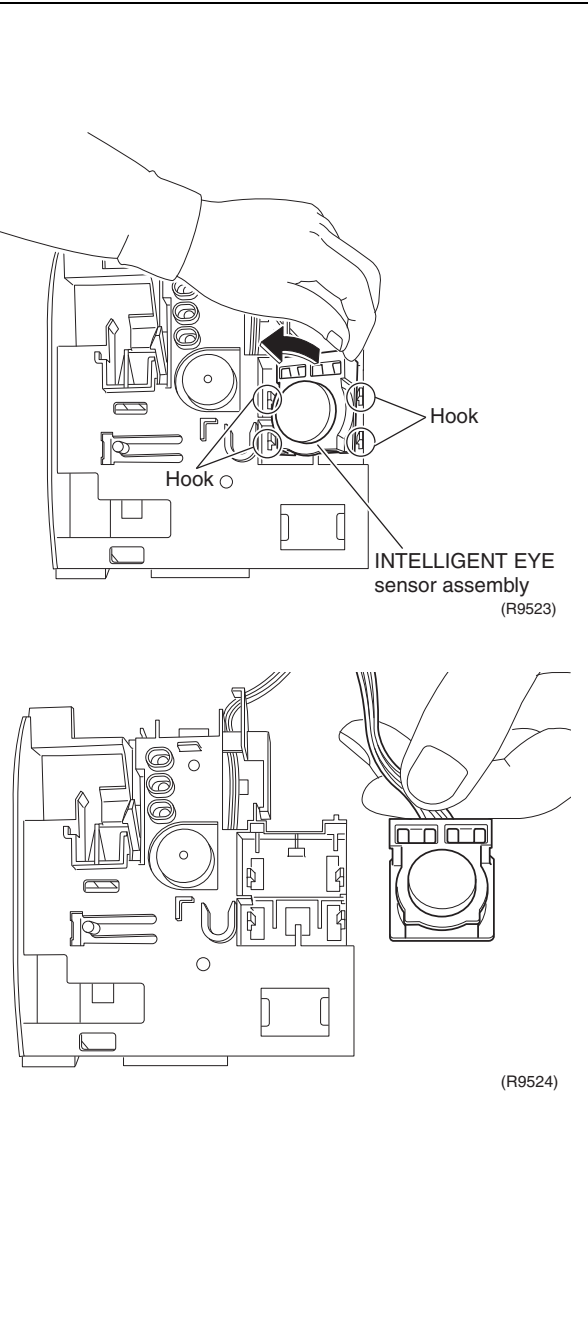
Step	Procedure	Points
7	<p>Disconnect the connector. [S48]: control PCB</p>  <p>[S48] (R9522)</p>	
2.	<p>Remove the INTELLIGENT EYE sensor PCB.</p> <p>1 Unfasten the 2 hooks on the right and then 2 hooks on the left. Remove the INTELLIGENT EYE sensor assembly.</p>  <p>Hook Hook O INTELLIGENT EYE sensor assembly (R9523)</p> <p>(R9524)</p>	

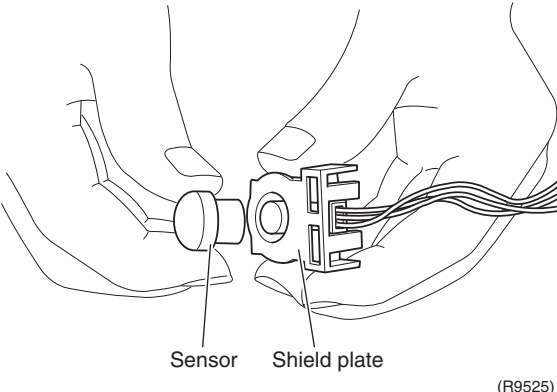
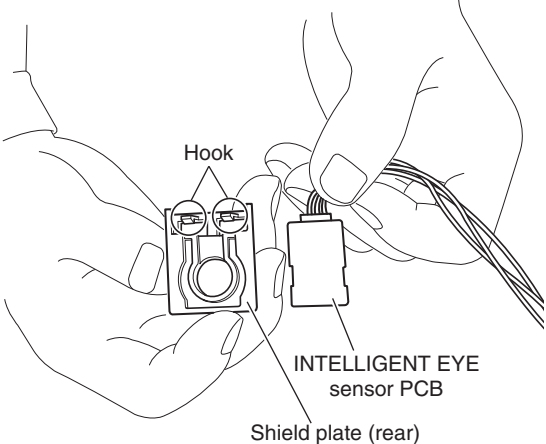
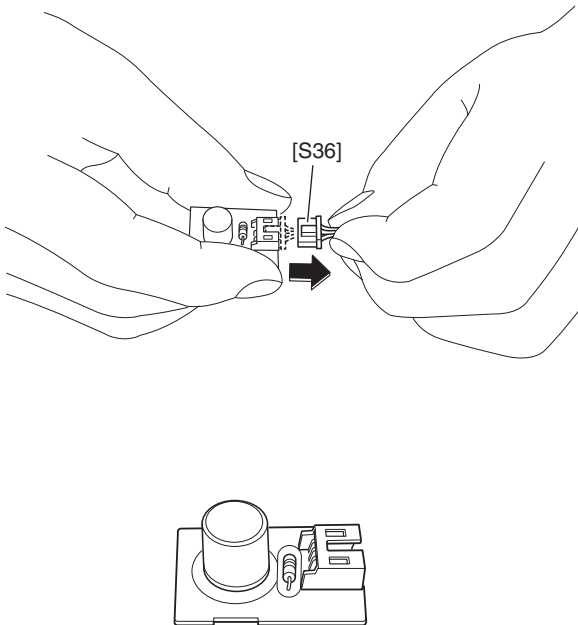
Step	Procedure	Procedure	Points
2	Remove the sensor from the shield plate.	 <p style="text-align: center;">Sensor Shield plate</p> <p style="text-align: right;">(R9525)</p>	<ul style="list-style-type: none"> ■ When reassembling, set the sensor at the position where it “clicks”. Otherwise, the sensor is not completely set.
3	Remove the shield plate by unfastening the 2 hooks.	 <p style="text-align: center;">Hook</p> <p style="text-align: center;">INTELLIGENT EYE sensor PCB</p> <p style="text-align: center;">Shield plate (rear)</p> <p style="text-align: right;">(R9526)</p>	
4	Disconnect the connector. [S36]: control PCB	 <p style="text-align: center;">[S36]</p> <p style="text-align: right;">(R9527)</p>	

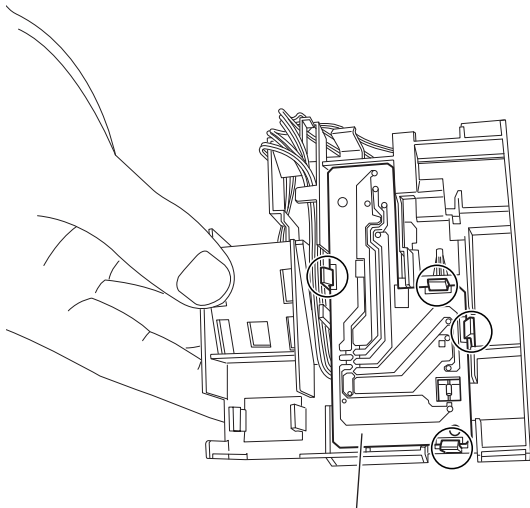
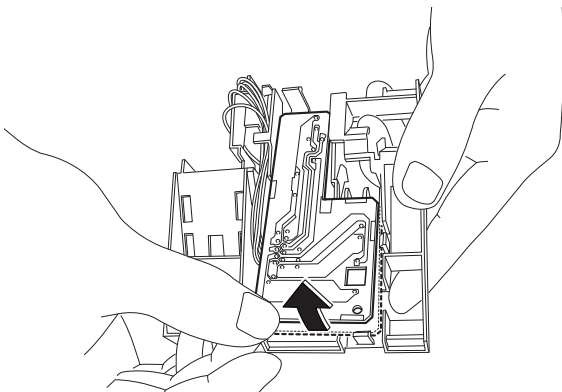
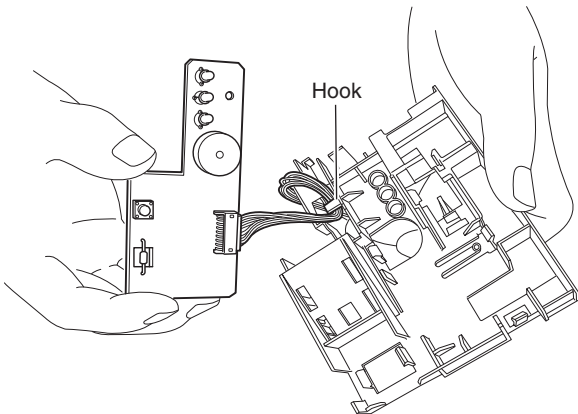
Step	Procedure	Points
3. Remove the display PCB.		
1	<p>Unfasten the 4 hooks.</p>  <p style="text-align: center;">Display PCB</p> <p style="text-align: right;">(R9528)</p>	
2	<p>Lift up the display PCB.</p>  <p style="text-align: right;">(R9529)</p>	
3	<p>Release the harness from the hook.</p>  <p style="text-align: right;">(R9530)</p>	

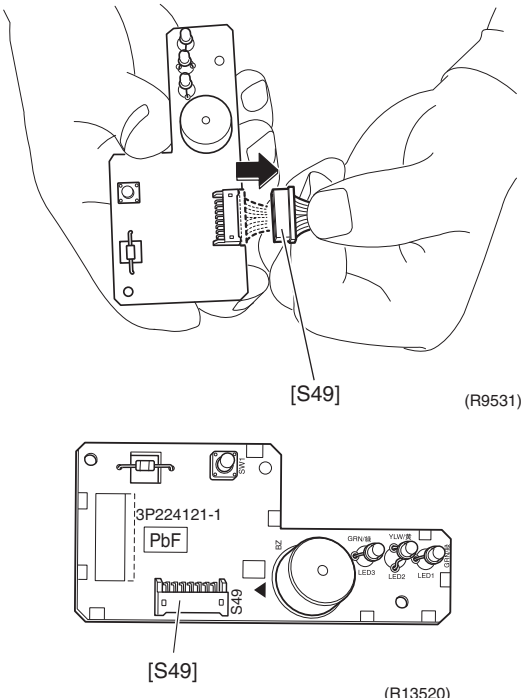
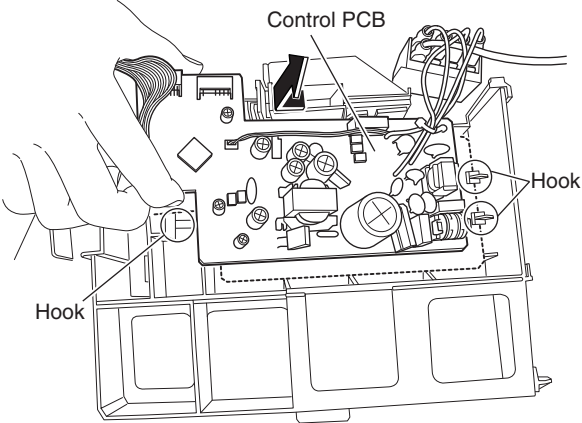
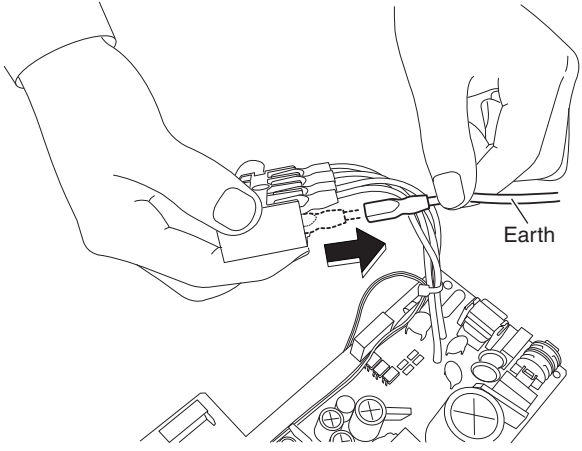
Step	Procedure	Points	Points
4	Disconnect the connector. [S49]: control PCB	 <p>[S49] (R9531)</p> <p>[S49] (R13520)</p>	
4. Remove the control PCB.			
1	Unfasten the 3 hooks. Lift up and remove the control PCB.	 <p>Control PCB</p> <p>Hook</p> <p>Hook</p> <p>(R9517)</p>	
2	Pull out the ground wire from the terminal board.	 <p>Earth</p> <p>(R9518)</p>	

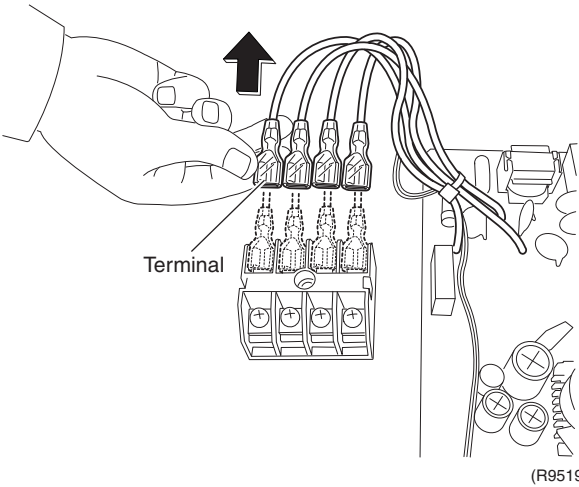
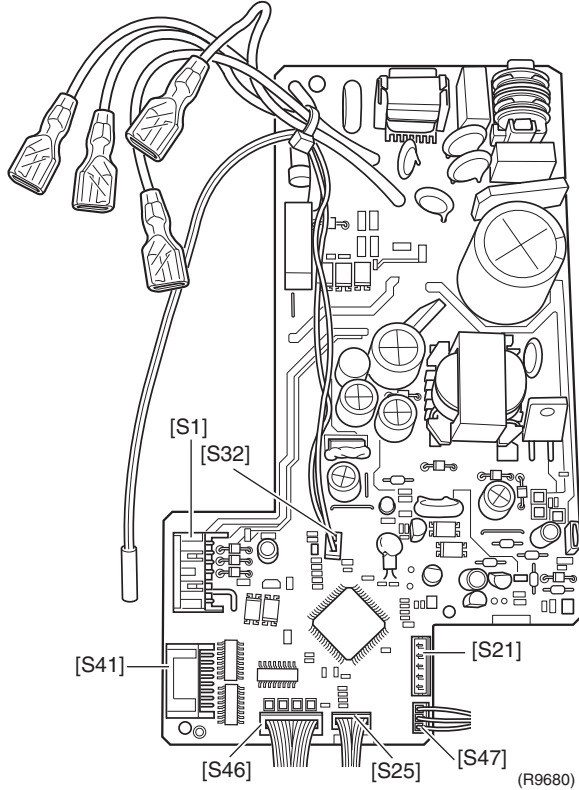
Step	Procedure	Points
3	<p data-bbox="196 212 467 275">Pull out the terminals from the terminal board.</p>  	<p data-bbox="1084 741 1474 1035"> [S1] : DC fan motor [S21] : HA connector [S25] : INTELLIGENT EYE sensor PCB [S32] : indoor heat exchanger thermistor [S41] : swing motors [S46] : display PCB [S47] : signal receiver PCB </p> <p data-bbox="1084 1073 1409 1098"> ■ Refer to page 8 for detail. </p>

1.5 Removal of Horizontal Blades / Vertical Blades / Swing Motors

Procedure

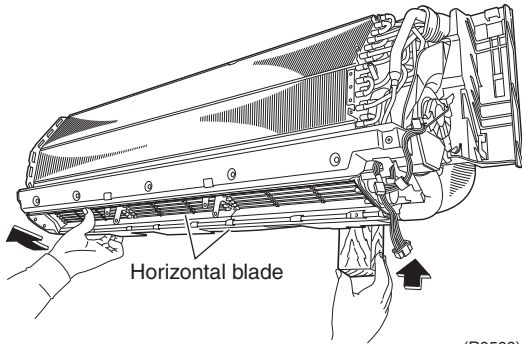
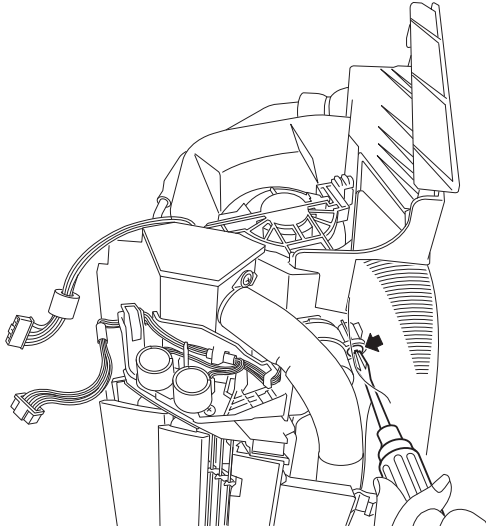
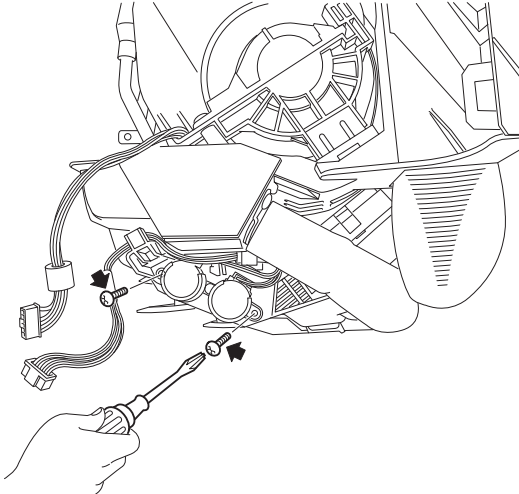

Warning Be sure to wait for 10 minutes or more after turning off all power supplies before disassembling work.

Step	Procedure	Points
1. Remove the horizontal blades.		
1	Hold the indoor unit up with a piece of wood etc.  <p style="text-align: right;">(R9568)</p>	
2	Remove the screw at the rear of the indoor unit.  <p style="text-align: right;">(R9533)</p>	
3	Remove the 2 screws (front and rear).  <p style="text-align: right;">(R9534)</p>	

Step		Procedure	Points
4	Release the shafts in turn.	<p>Horizontal blade</p> <p>right</p> <p>(R9535)</p> <p>left</p> <p>(R9536)</p> <p>inner right</p> <p>(R9537)</p> <p>inner left</p> <p>(R9538)</p>	<ul style="list-style-type: none"> ■ Removing order (right → left → inner right → inner left)

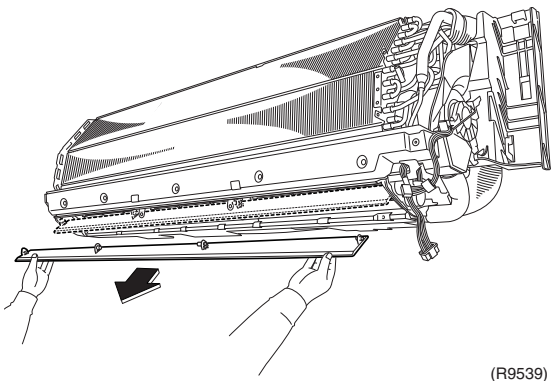
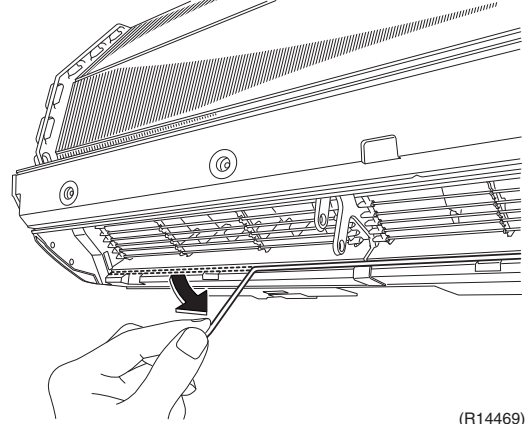
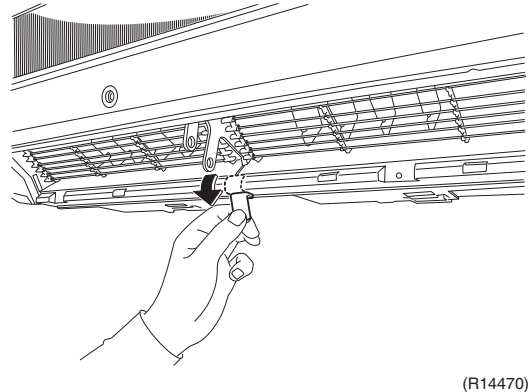
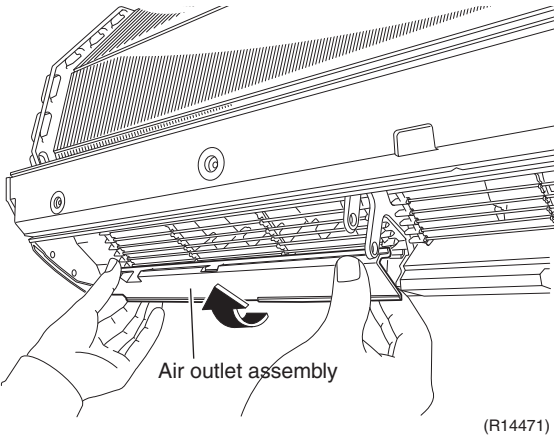
Step	Procedure	Procedure	Points
5	Remove the horizontal blades.		
2. Remove the fan guards.			
1	Remove the sealing material (horizontal).		
2	Remove the sealing material (vertical). Also remove the other sealing material on the right.		
3	Remove the left air outlet assembly by pushing the 2 hooks at the back.		<p>■ Remove the center and right air outlet assembly likewise.</p>

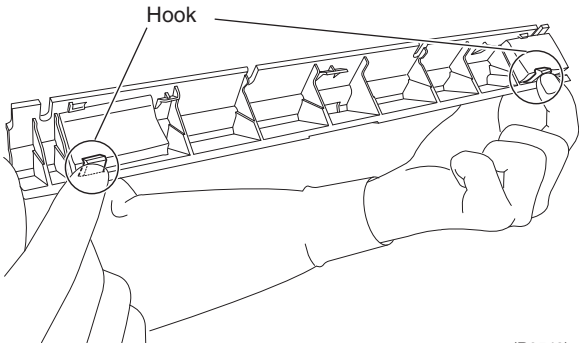
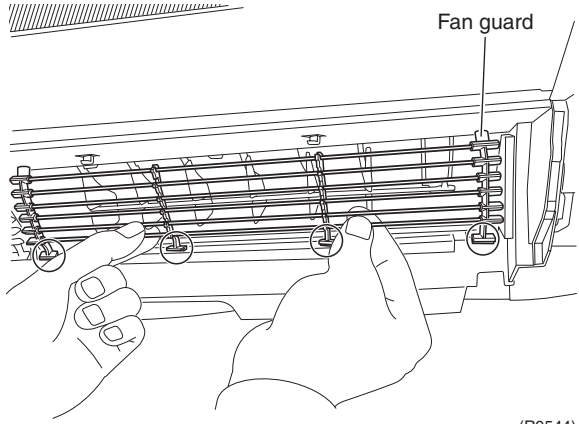
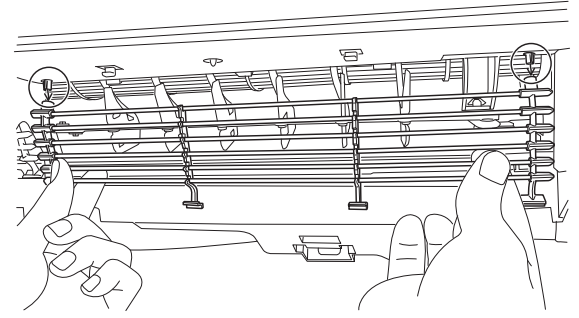
Step	Procedure	Points
<p>4</p>	<p>Unfasten the 4 lower hooks and the 2 upper hooks and remove the fan guard.</p>  <p>Hook</p> <p>(R9543)</p>  <p>Fan guard</p> <p>(R9544)</p>  <p>(R9545)</p>	

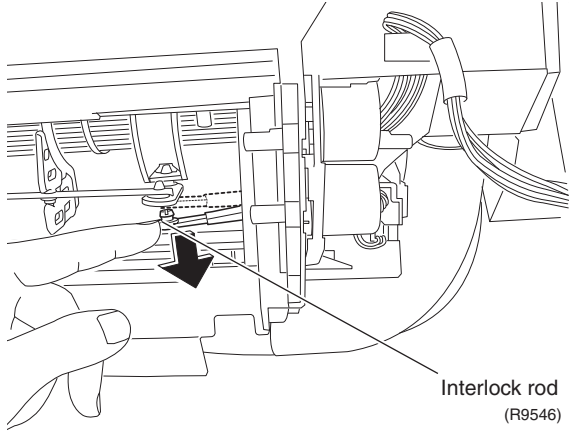
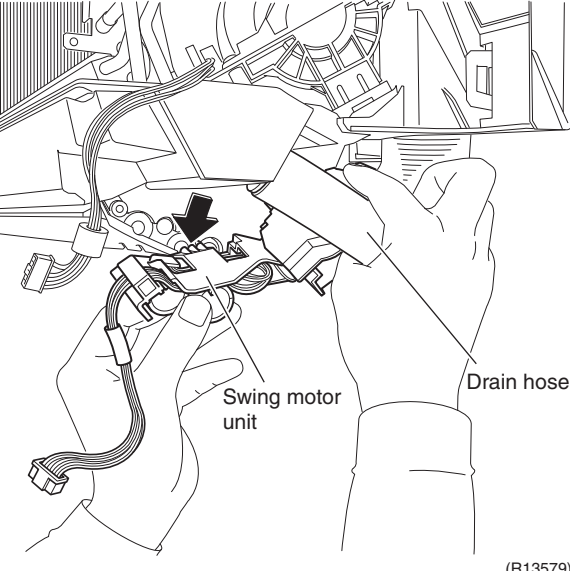
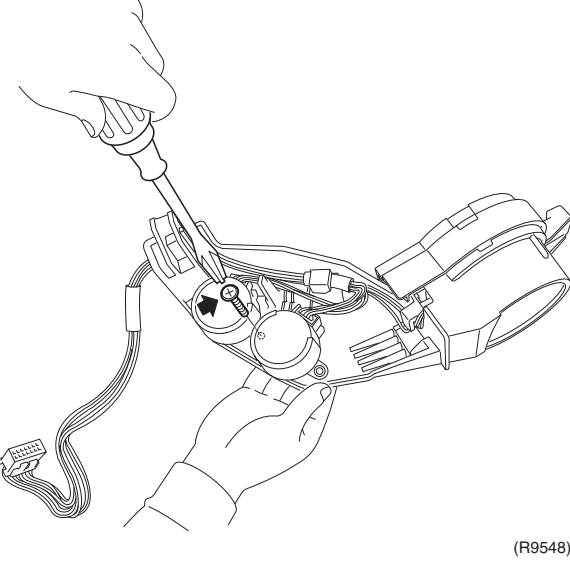
Step	Procedure	Points
3.	Remove the swing motors for horizontal blades.	
1	Release the interlock rod.	
2	Pull out the drain hose, then remove the swing motor unit.	
3	Remove the screw at the center.	

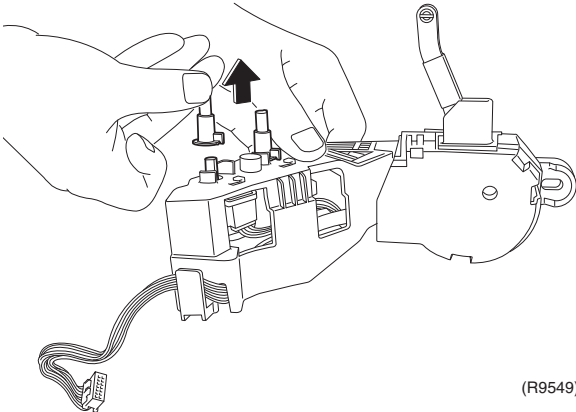
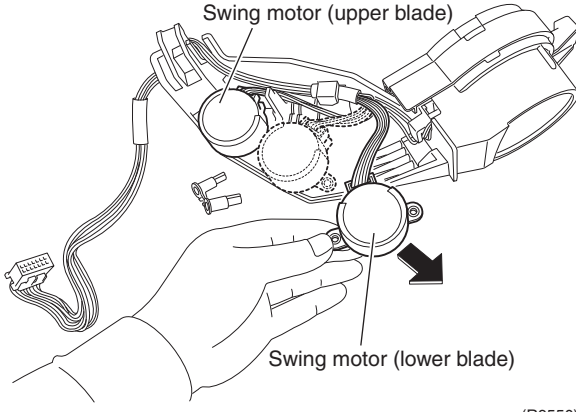
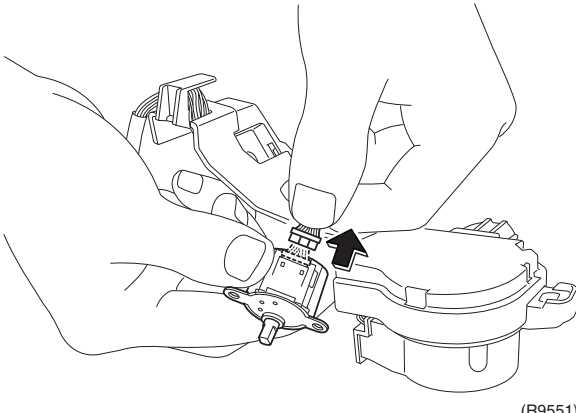
Step	Procedure	Procedure	Points
4	Remove the 2 pivots.	 <p>(R9549)</p>	
5	Remove the swing motors.	 <p>(R9550)</p>	<p>⚠ Caution When reassembling, do not confuse the installing order of the 2 motors and the colors of the connectors. If you set the connectors or motors opposite, the horizontal blades might not move smoothly and could cause sounds.</p> <p>(1) Set the swing motor for the upper blade first. (connector: white)</p> <p>(2) Then, set the swing motor for the lower blade. (connector: red)</p> <p>(3) Fix both the swing motors with a screw.</p>
6	Disconnect the connector to remove the swing motor.	 <p>(R9551)</p>	

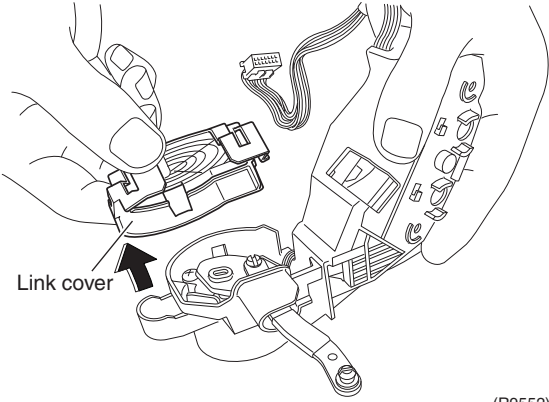
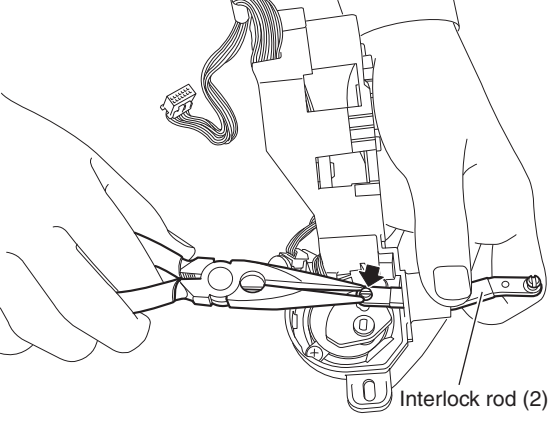
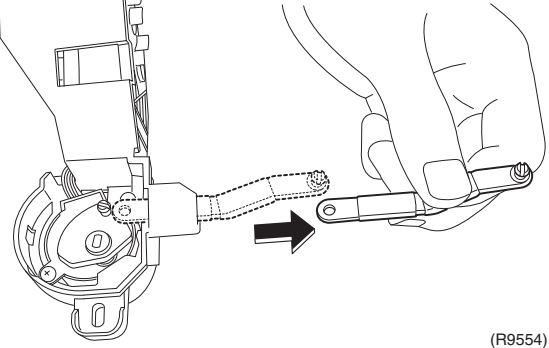
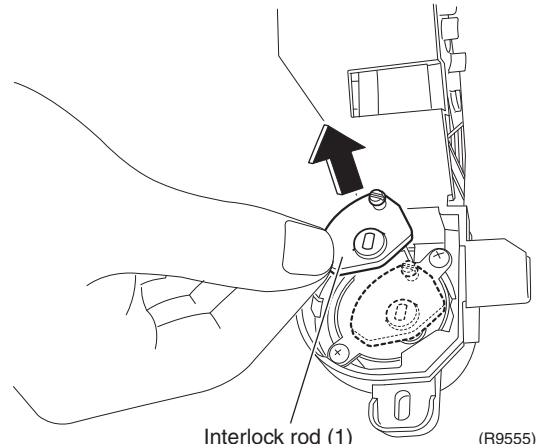
Step	Procedure	Points
4.	Remove the swing motor for vertical blades.	
1	Remove the link cover.  <p>Link cover</p> <p>(R9552)</p>	
2	Remove the interlock rod (2) with pliers.  <p>Interlock rod (2)</p> <p>(R9553)</p>	
3	Remove the interlock rod (1).  <p>(R9554)</p>  <p>Interlock rod (1)</p> <p>(R9555)</p>	

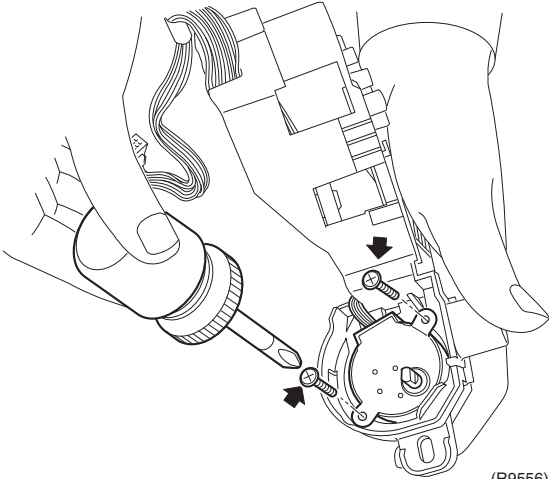
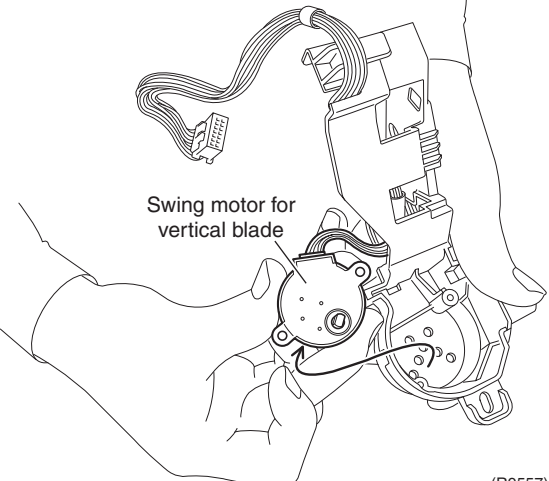
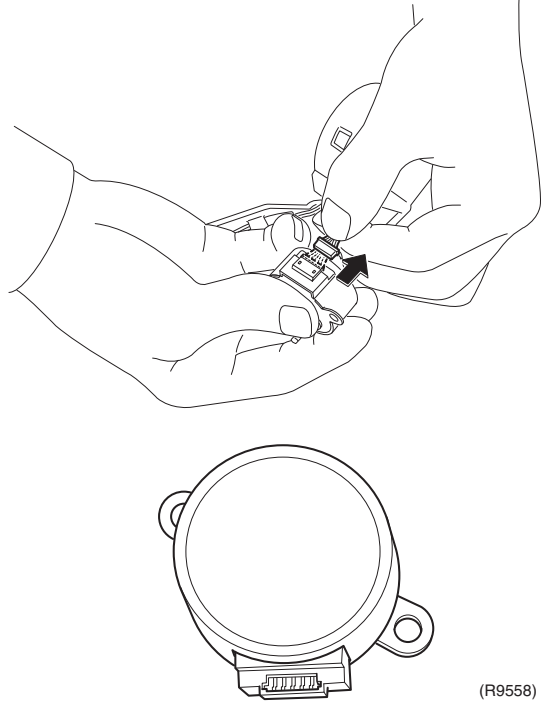
Step	Procedure	Procedure	Points
4	Remove the 2 screws.	 <p>(R9556)</p>	
5	Remove the swing motor for vertical blade.	 <p>Swing motor for vertical blade</p> <p>(R9557)</p>	
6	Disconnect the connector.	 <p>(R9558)</p>	

1.6 Removal of Fan Motor

Procedure

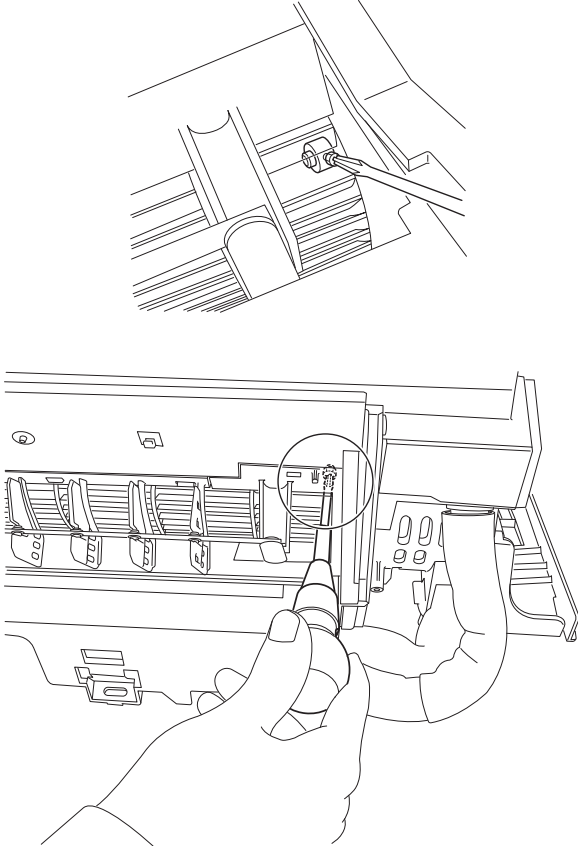
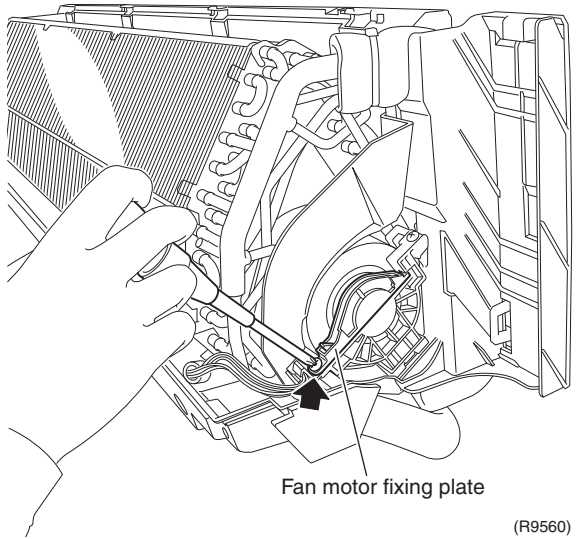

Warning Be sure to wait for 10 minutes or more after turning off all power supplies before disassembling work.

Step	Procedure	Points
1	<p>Loosen the screw of the fan motor from the air outlet.</p>  <p>(R9559)</p>	
2	<p>Remove the screw of the fan motor fixing plate.</p>  <p>Fan motor fixing plate</p> <p>(R9560)</p>	

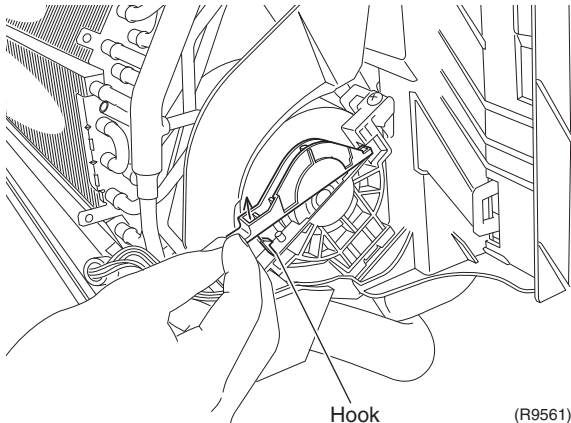
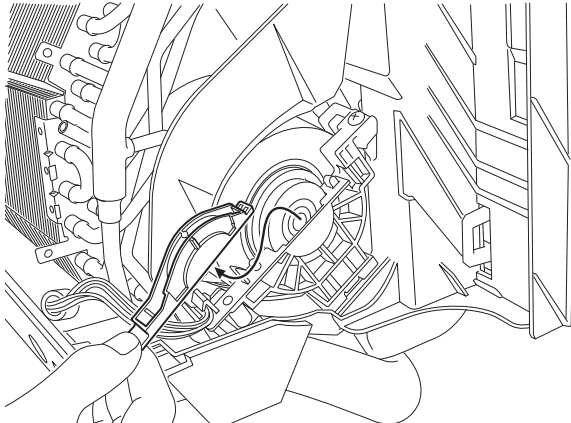
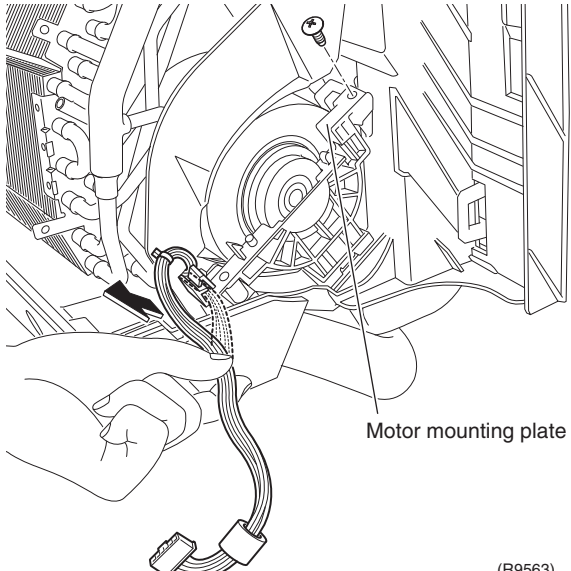
Step	Procedure	Points	Points
3	<p>Unfasten the hook at the front and remove the fan motor fixing plate.</p>	 <p>Hook (R9561)</p>  <p>(R9562)</p>	
4	<p>Release the harness from the hook, and remove the screw of the motor mounting plate.</p>	 <p>Motor mounting plate (R9563)</p>	

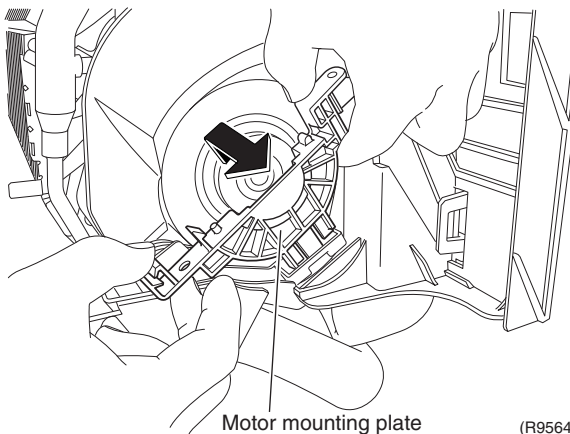
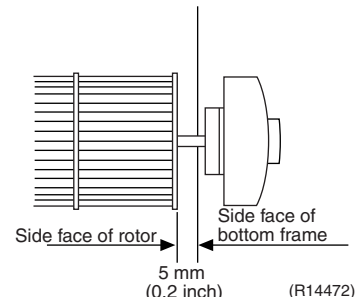
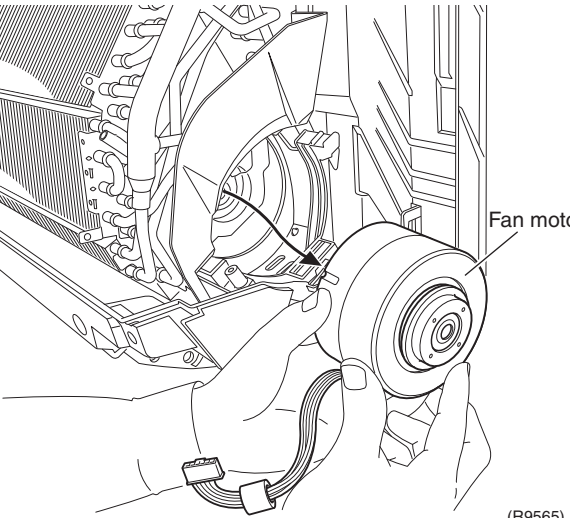
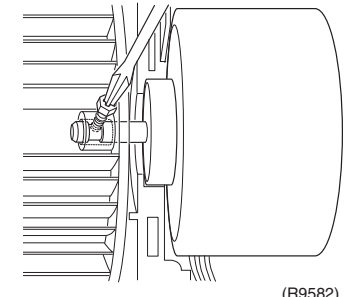
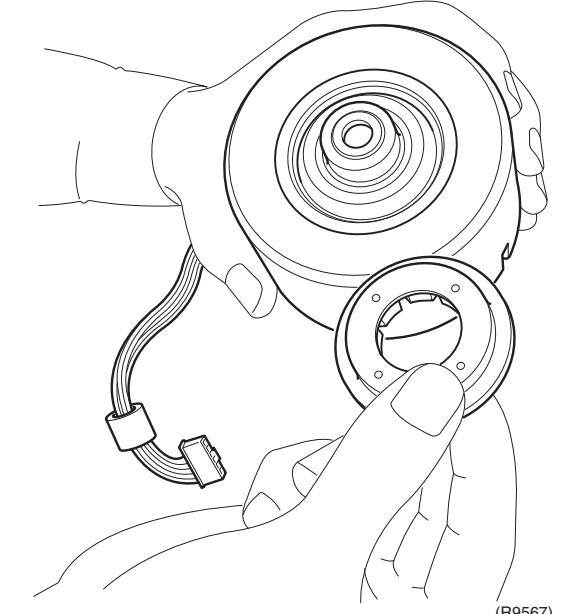
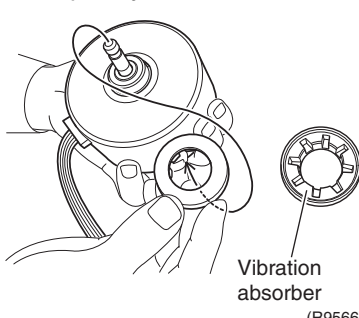
Step	Procedure	Procedure	Points
5	Remove the motor mounting plate.	 <p>Motor mounting plate (R9564)</p>	<p>■ Reassembling the fan motor When reassembling the fan rotor, provide as much as 5 mm (0.2 inch) of play between the side face of the rotor and the bottom frame.</p>  <p>Side face of rotor Side face of bottom frame 5 mm (0.2 inch) (R14472)</p>
6	Remove the fan motor.	 <p>Fan motor (R9565)</p>	 <p>(R9582)</p> <ol style="list-style-type: none"> (1) Insert the fan motor with approx. 5 mm (0.2 inch) left. (2) Tighten the screw until it stops. Then turn the screw in one scroll. (3) Move the fan rotor and confirm the fan motor and the fan rotor are installed appropriately. (4) Tighten the screw completely if appropriate. (5) If not appropriate, go back to (1).
7	Remove the vibration absorber.	 <p>(R9567)</p>	<p>■ When reassembling, engage the vibration absorber completely.</p>  <p>Vibration absorber (R9566)</p>

1.7 Removal of Indoor Heat Exchanger

Procedure



Warning Be sure to wait for 10 minutes or more after turning off all power supplies before disassembling work.

Step	Procedure	Points
1. Disconnect the refrigerant piping.		<p>Preparation</p> <ul style="list-style-type: none"> Remove the electrical box according to the "Removal of Electrical Box" instructions.
1 Hold the indoor unit up with a piece of wood or other prop.	<p>(R11406)</p>	<p>Caution</p> <p>If the refrigerant leaks, repair the leak, then collect all refrigerant from the unit. After conducting vacuum drying, recharge proper amount of refrigerant.</p>
2 Pull out the drain hose.	<p>Drain hose</p> <p>(R9569)</p>	<p>Caution</p> <p>For global environment protection, be sure to use a vacuum pump for air purging.</p> <p>Caution</p> <p>In pump-down work, be sure to stop the compressor before disconnecting the refrigerant piping. If the refrigerant piping is disconnected with the compressor operating and with the stop valve open, air may be sucked in to generate an over-pressure in refrigeration cycle, thus resulting in pipe rupture or accidental injury.</p>
3 Unscrew the flare nuts for gas piping and liquid piping with 2 wrenches.	<p>Gas piping</p> <p>Liquid piping</p> <p>(R9570)</p>	<ul style="list-style-type: none"> Place a plastic sheet under the drain pan to prevent wetting the floor with remaining drainage. If the drain hose is embedded in the wall, disconnect the drain hose beforehand. Carry out the removal work with 2 wrenches. When the pipings are disconnected, protect the pipes and unit from moisture entering.

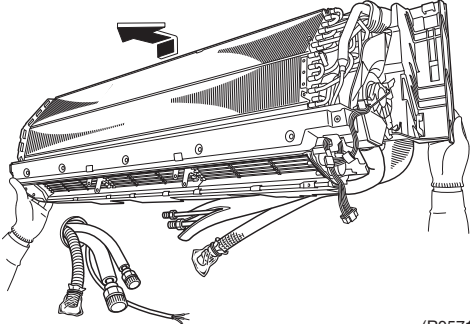
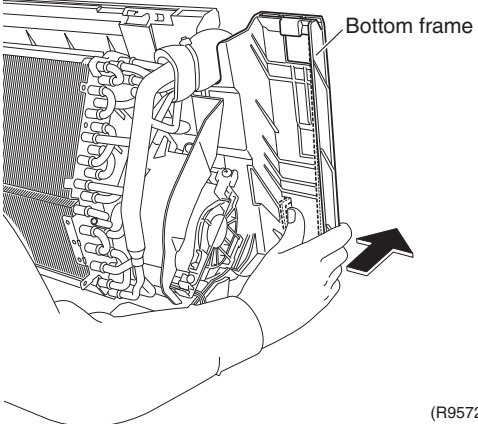
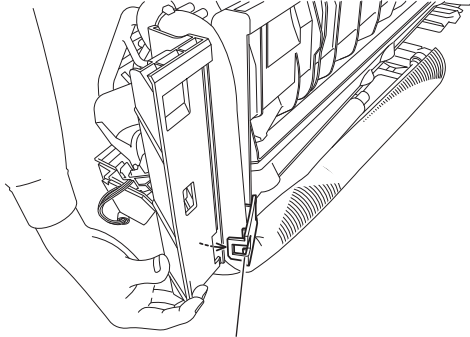
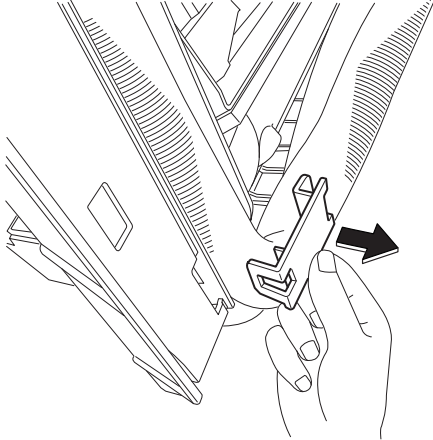
Step	Procedure	Points
2.	Remove the piping fixture.	
1	Detach the indoor unit from the installation plate.  (R9571)	
2	Push the bottom frame.  (R9572)	
3	Release the piping fixture.  (R9573)	
4	Remove the piping fixture.  (R9574)	

Step	Procedure	Points
3.	Remove the indoor heat exchanger.	
1	Widen the auxiliary piping.	<ul style="list-style-type: none"> ■ At an angle of 10° ~ 20°
2	Remove the 2 screws on the left side.	<p>⚠ Caution When removing or reassembling the indoor heat exchanger, be sure to wear gloves or wrap it with cloth to prevent injury from the fins.</p>
3	Push the hook on the right side and unfasten it.	
4	Lift up and remove the indoor heat exchanger.	<ul style="list-style-type: none"> ■ Press the right side of the indoor heat exchanger, and lift it up from the left side.

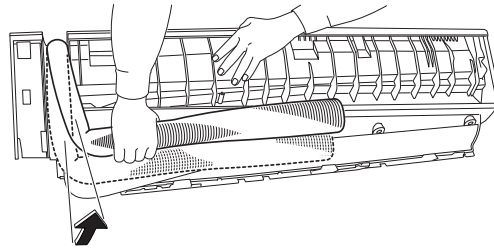

(R9575)

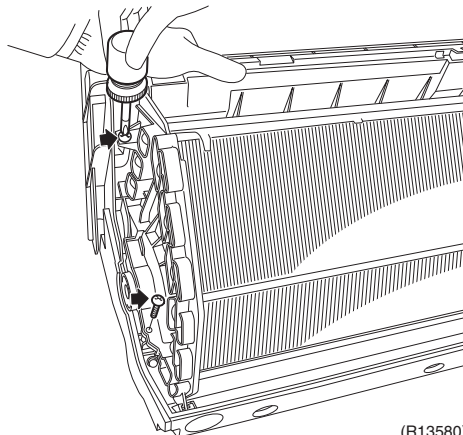

(R13580)

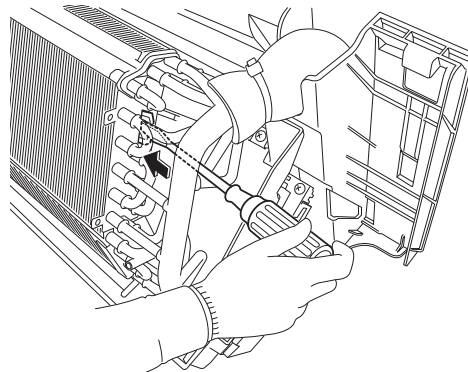

(R13581)

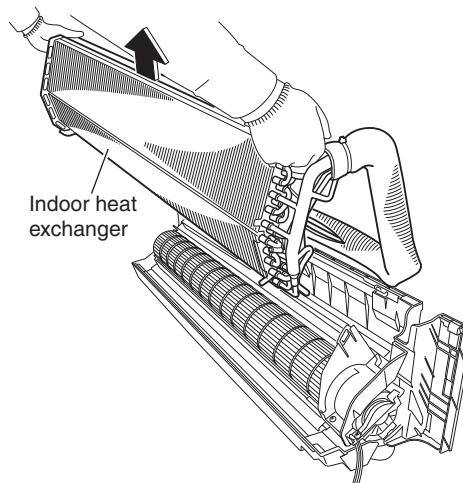

(R9578)

1.8 Removal of Fan Rotor

Procedure



Warning Be sure to wait for 10 minutes or more after turning off all power supplies before disassembling work.

Step	Procedure	Points
1. Remove the right side plate.		
1	Remove the 2 screws.	
2	Lift the right side plate and remove it.	
2. Remove the fan rotor.		
1	Remove the screw of the fan motor fixing plate and remove it.	

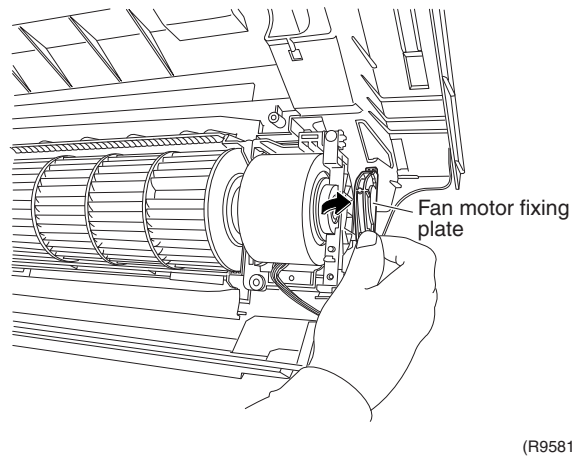
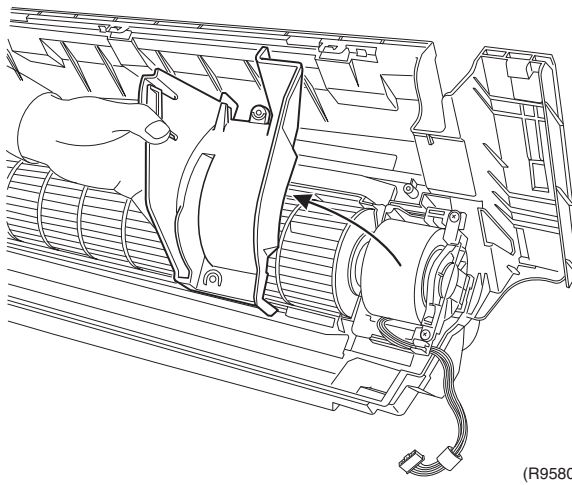
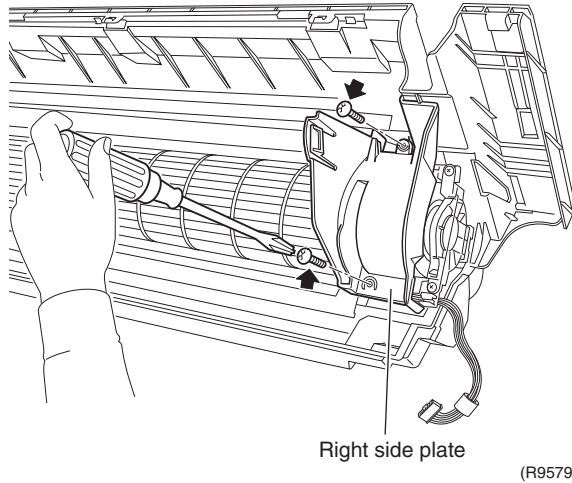

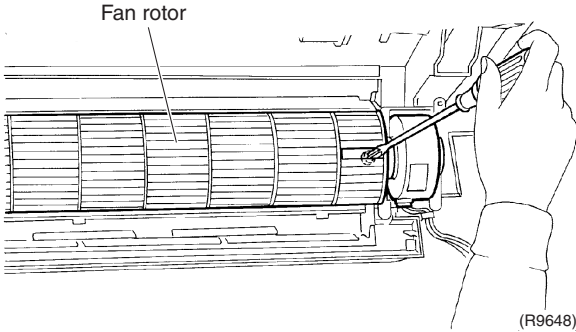
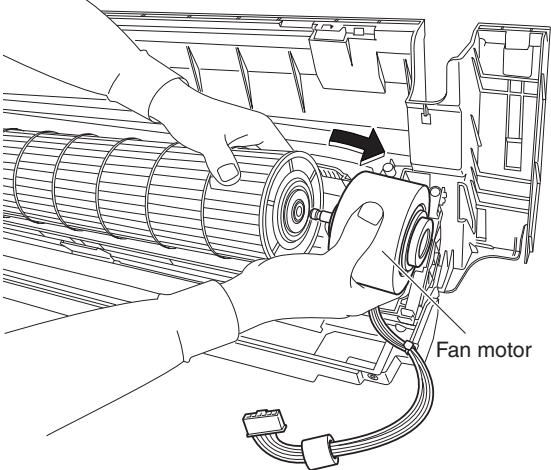
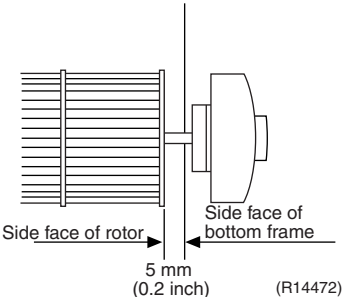
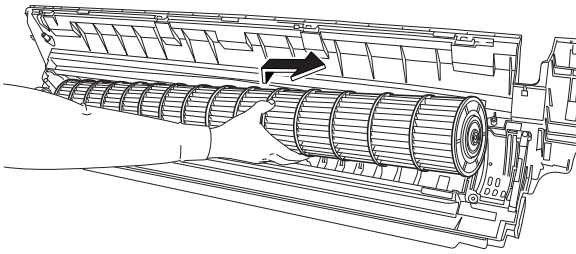
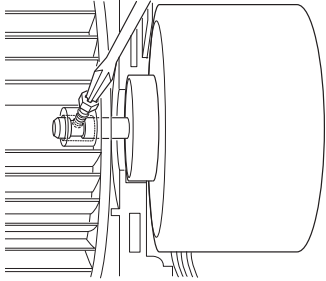
Step		Procedure	Points
2	Remove the screw of the fan rotor.	 <p>(R9648)</p>	
3	Remove the fan motor.	 <p>(R9583)</p>	<p>■ Reassembling the fan motor When reassembling the fan rotor, provide as much as 1/2" (5 mm) of play between the side face of the rotor and the bottom frame.</p>  <p>(R14472)</p>
4	Remove the fan rotor.	 <p>(R9584)</p>	 <p>(R9582)</p> <ol style="list-style-type: none"> (1) Insert the fan motor with approx. 1/2" (5 mm) left. (2) Tighten the screw until it stops. Then turn the screw in one scroll. (3) Move the fan rotor and verify that both the fan motor and fan rotor are installed. correctly. (4) Tighten the screw completely if applicable. (5) If not applicable, go back to (1).

2. Outdoor Unit

Note: The illustrations represent heat pump models.

2.1 Removal of Outer Panels

Procedure

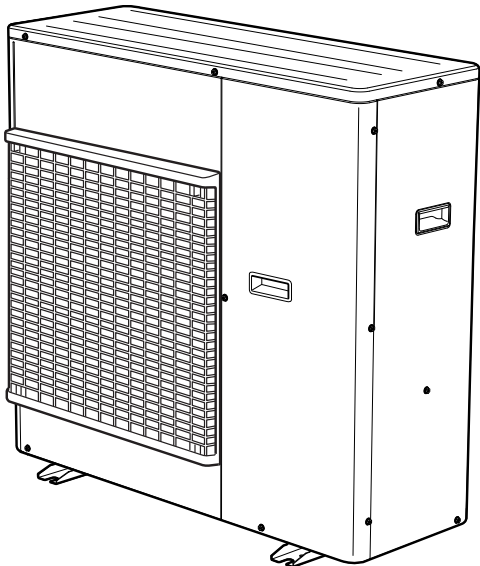
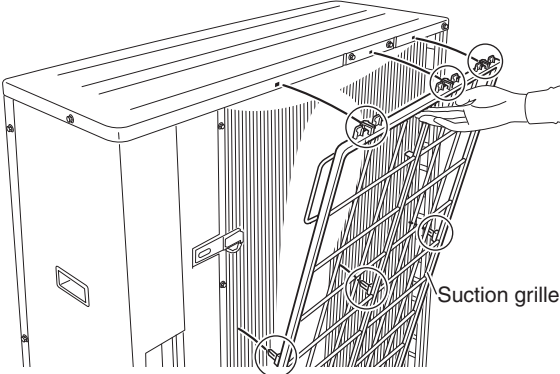
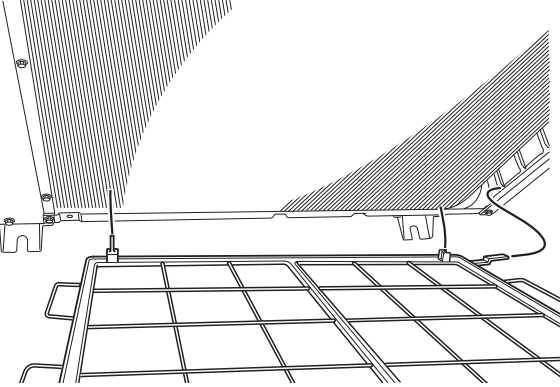

Warning Be sure to wait for 10 minutes or more after turning off all power supplies before disassembling work.

Step	Procedure	Points
1. Features	 <p style="text-align: right;">(R9749)</p>	
2. Remove the suction grille.	<p>1 Release the 3 hooks at the upper first, and then 3 hooks at the middle.</p>  <p style="text-align: right;">(R9586)</p> <p>2 Release the 3 hooks at the bottom and remove the suction grille.</p>  <p style="text-align: right;">(R9587)</p>	<p>■ The hooks are secured in the clearances of the outdoor heat exchanger fins.</p>

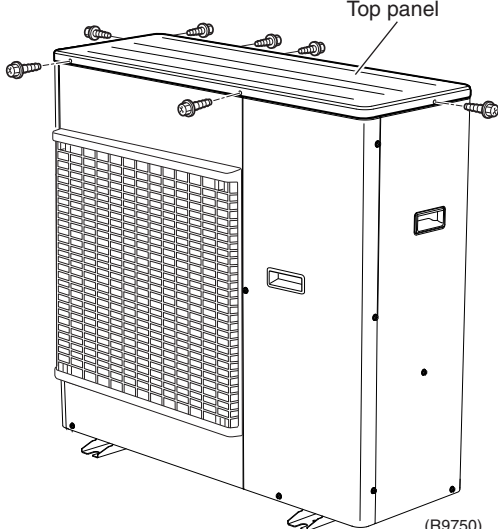
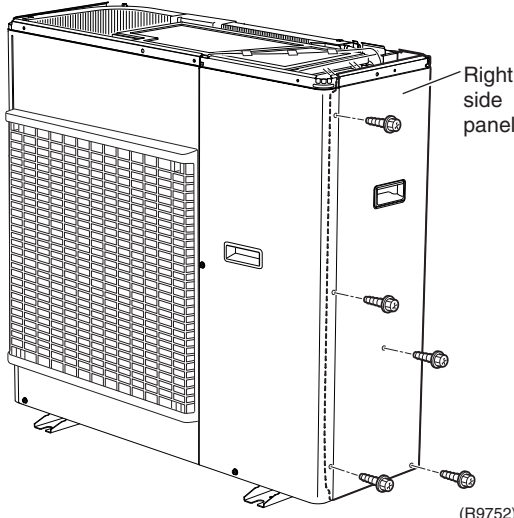
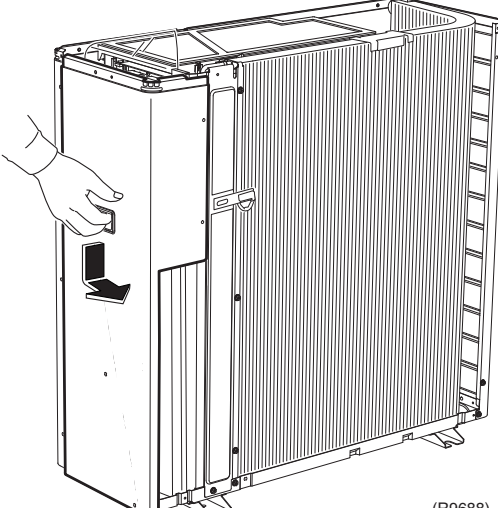
Step	Procedure	Points
<p>3. Remove the top panel.</p> <p>1 Remove the 7 screws and remove the top panel.</p>	 <p style="text-align: right;">(R9750)</p>	
<p>4. Remove the right side panel.</p> <p>1 Remove the 5 screws.</p> <p>2 Slide the right side panel downward to unfasten the 2 hooks on the back side.</p>	 <p style="text-align: right;">(R9752)</p>  <p style="text-align: right;">(R9688)</p>	

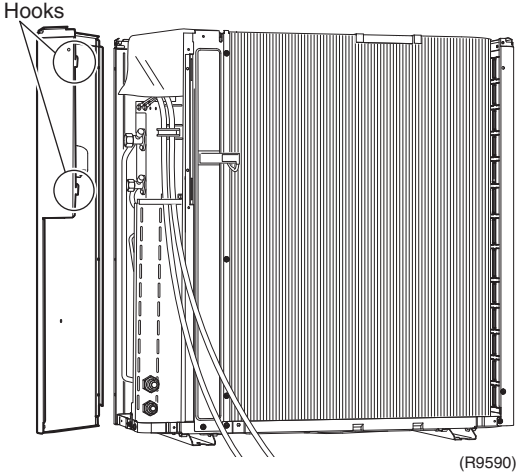
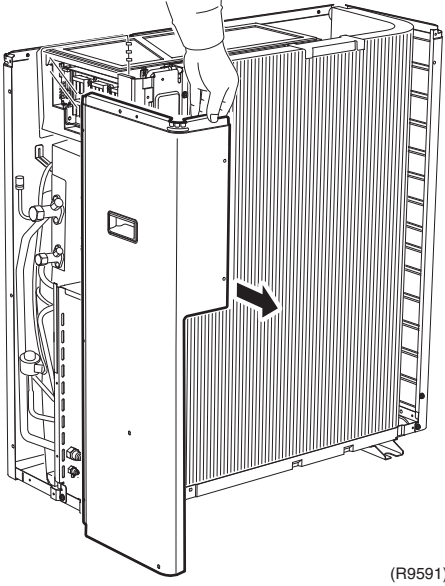
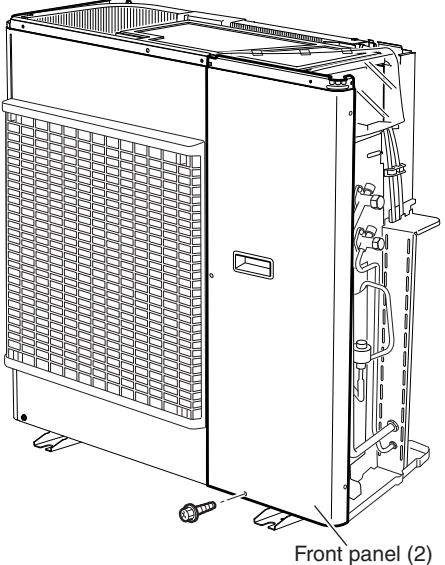
Step	Procedure	Points
3	<p>Remove the right side panel.</p>  <p>(R9590)</p>  <p>(R9591)</p>	
5.	<p>Remove the front panel (2).</p> <p>1 Remove the 1 screw.</p>  <p>Front panel (2)</p> <p>(R9753)</p>	

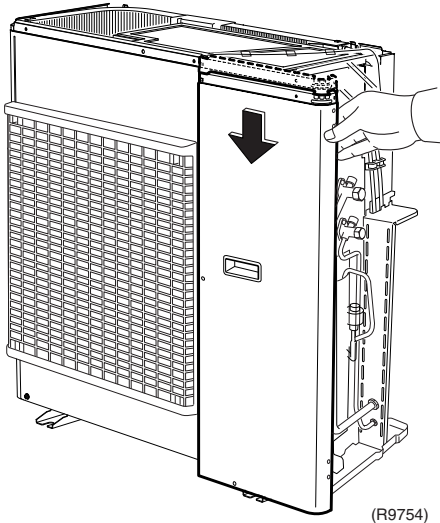
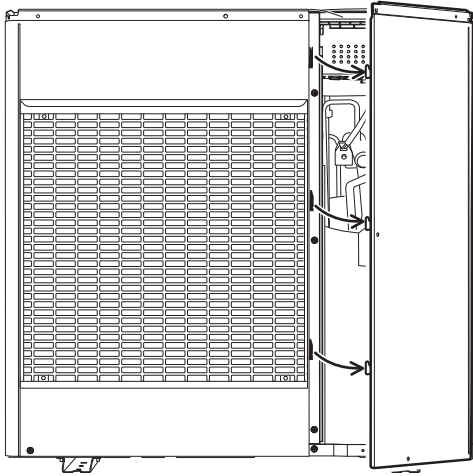
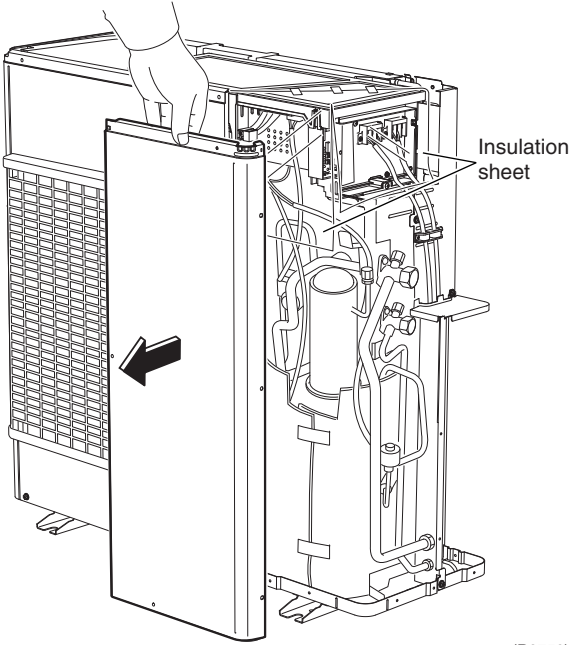
Step	Procedure	Points
2	<p>Slide the front panel (2) downward to unfasten the 3 hooks.</p>  <p>(R9754)</p>  <p>(R9755)</p>	
3	<p>Remove the front panel (2).</p>  <p>(R9756)</p>	<ul style="list-style-type: none"> ■ The insulation sheet is inserted between the front panel (2) and the electrical box.

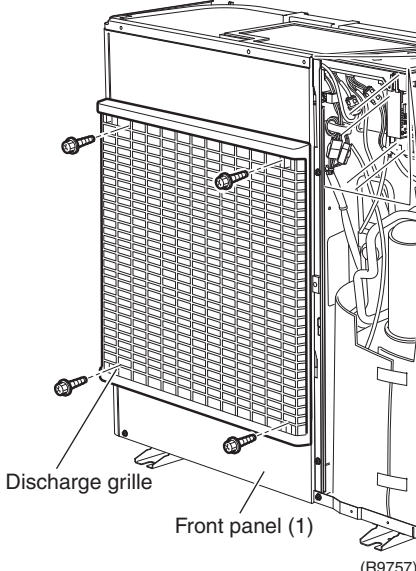
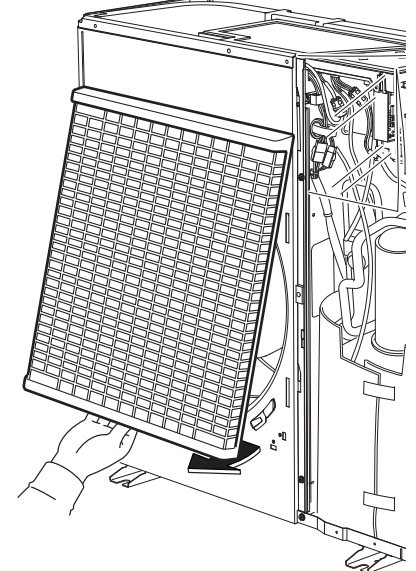
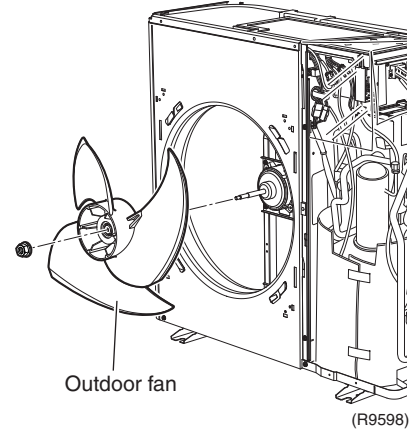
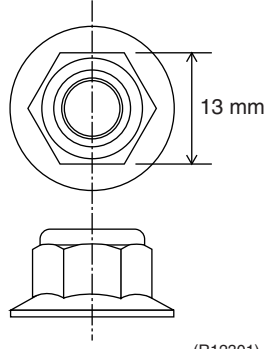
Step	Procedure	Points
6. Remove the front panel (1).		<ul style="list-style-type: none"> Remove the discharge grille and the outdoor fan first to remove the front panel (1).
1 Remove the 4 screws on the discharge grille.	 <p>Discharge grille</p> <p>Front panel (1)</p> <p>(R9757)</p>	
2 Pull out the bottom of the discharge grille and remove it.	 <p>(R9758)</p>	
3 Remove the outdoor fan fixing-nut.	 <p>Outdoor fan</p> <p>(R9598)</p>	<ul style="list-style-type: none"> Nut size: M8  <p>13 mm</p> <p>(R12301)</p>

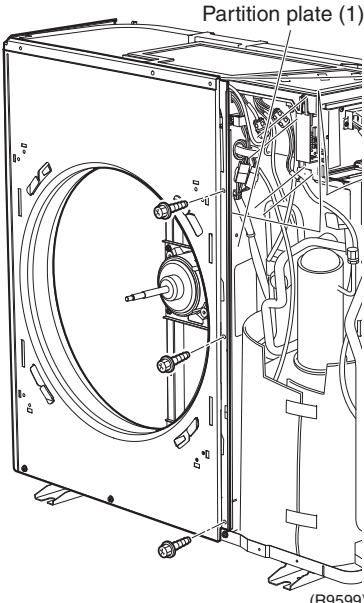
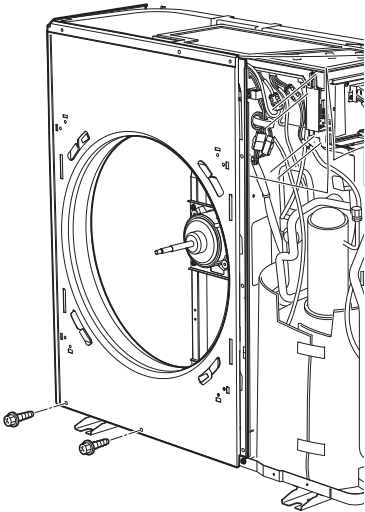
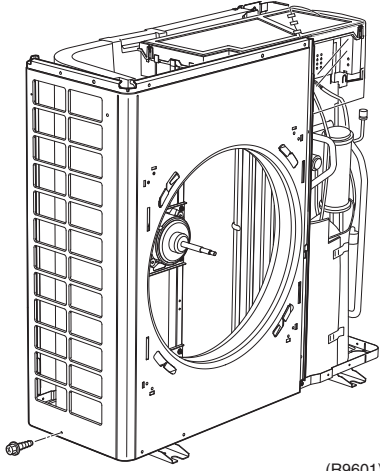
Step	Procedure	Procedure	Points
4	Remove the 3 screws on the partition plate (1).	 <p>Partition plate (1)</p> <p>(R9599)</p>	
5	Remove the 2 screws at the bottom of the front.	 <p>(R9600)</p>	
6	Remove the screw at the bottom of the left side.	 <p>(R9601)</p>	

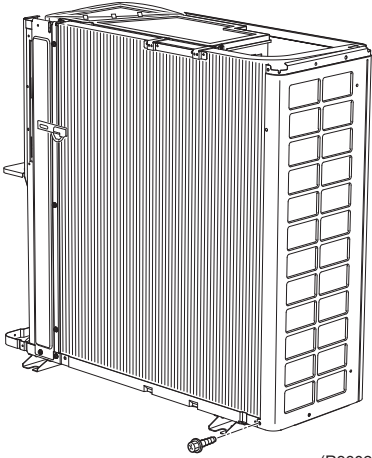
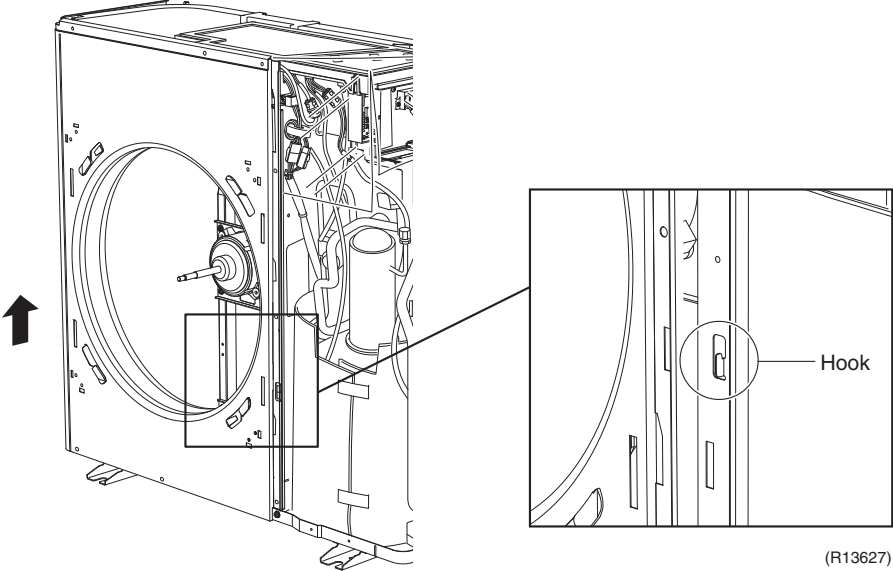
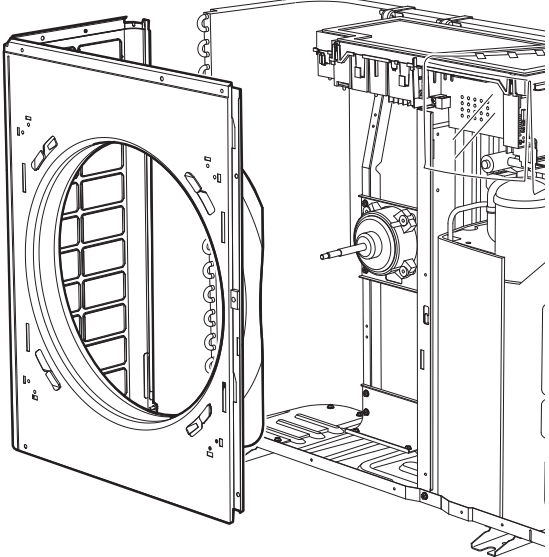
Step	Procedure	Procedure	Points
7	Remove the screw at the bottom of the back side.	 <p>(R9602)</p>	
8	The front panel (1) has a hook on its front. Lift the front panel (1).	 <p>(R13627)</p>	
9	Remove the front panel (1).	 <p>(R9604)</p>	

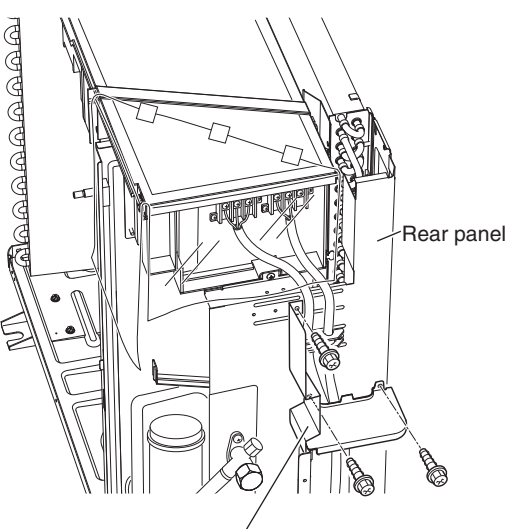
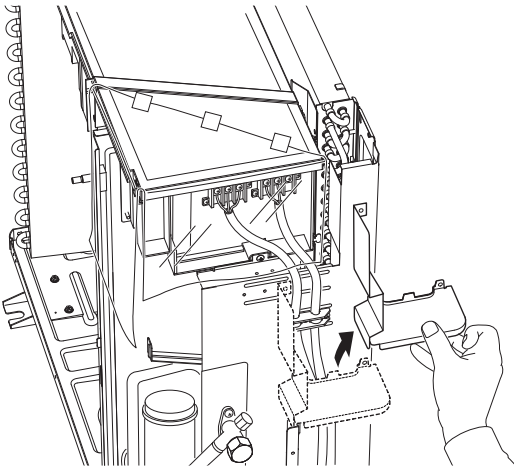
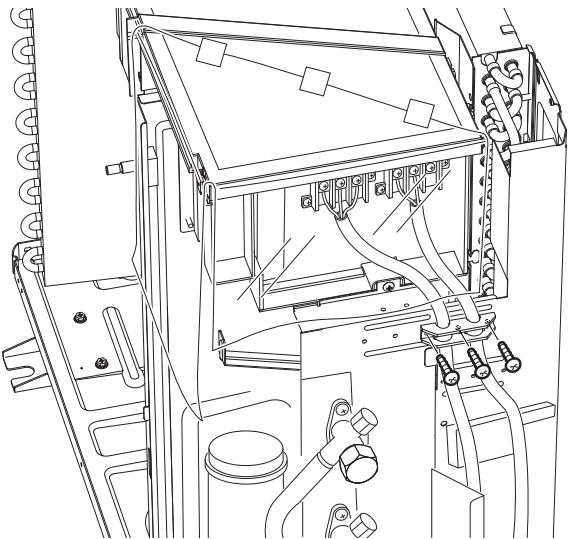
Step	Procedure	Points
7. Remove the rear panel.		
1	<p>Remove the 3 screws on the partition plate (2).</p>  <p style="text-align: right;">(R14473)</p>	
2	<p>Lift up slightly and remove the partition plate (2).</p>  <p style="text-align: right;">(R9760)</p>	
3	<p>Remove the 3 screws.</p>  <p style="text-align: right;">(R9607)</p>	

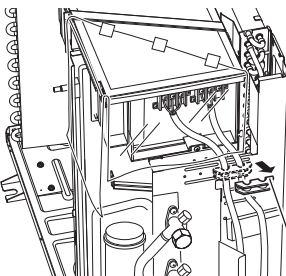
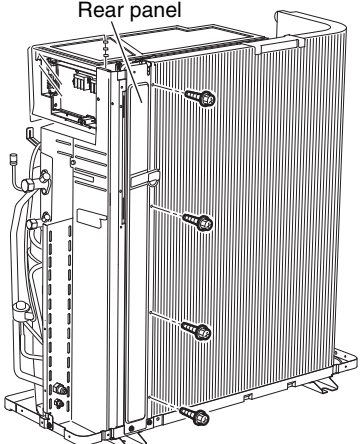
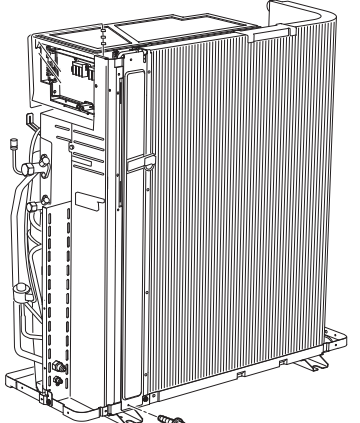
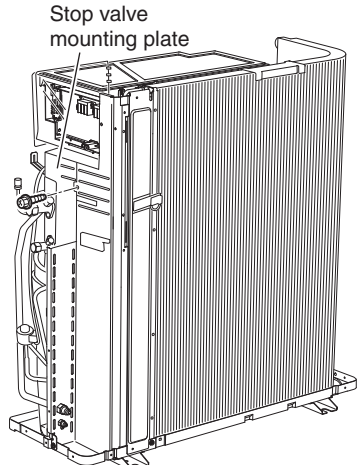
Step	Procedure	Procedure	Points
4	Remove the wire fixing plate.	 <p>Wire fixing plate (R9608)</p>	
5	Remove the 4 screws on the rear panel.	 <p>Rear panel (R9609)</p>	
6	Remove the screw on the bottom frame.	 <p>(R9610)</p>	
7	Remove the screw on the stop valve mounting plate.	 <p>Stop valve mounting plate (R9612)</p>	

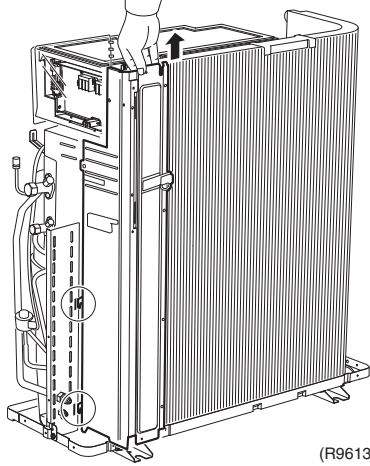
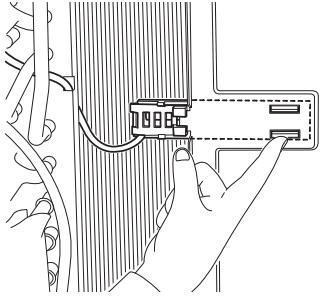
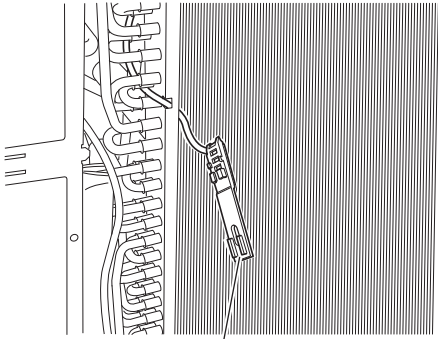
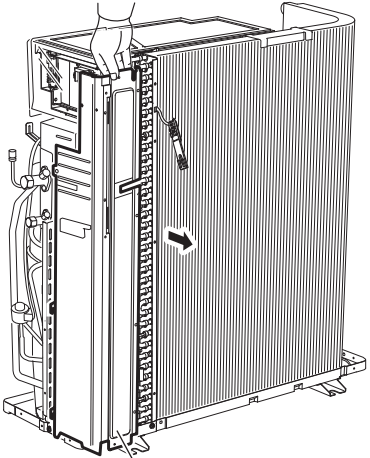
Step	Procedure	Procedure	Points
8	Lift the rear panel upward to unfasten the 2 hooks.	 <p>(R9613)</p>	
9	Push the hooks of the outdoor temperature thermistor holder from inner-side of the rear panel and detach it.	 <p>(R9615)</p>  <p>Outdoor temperature thermistor holder (R9616)</p>	
10	Remove the rear panel.	 <p>Rear panel (R9614)</p>	

2.2 Removal of Electrical Box

Procedure



Warning Be sure to wait for 10 minutes or more after turning off all power supplies before disassembling work.

Step	Procedure	Points
1	Remove the screw on the stop-valve mounting plate.	
2	Remove the screw on the partition plate (1).	
3	Remove the 2 screws to detach the ground wires.	

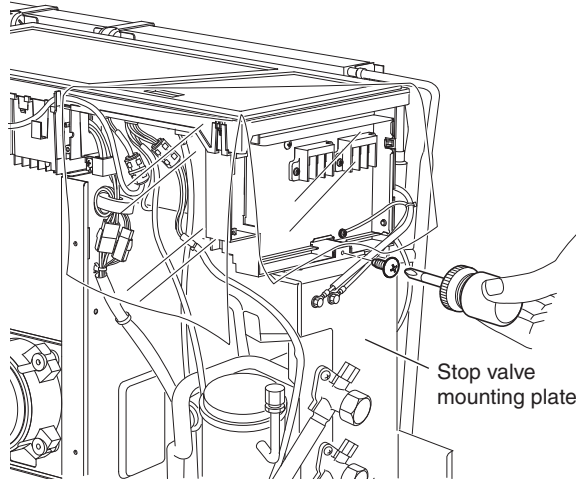

(R9617)

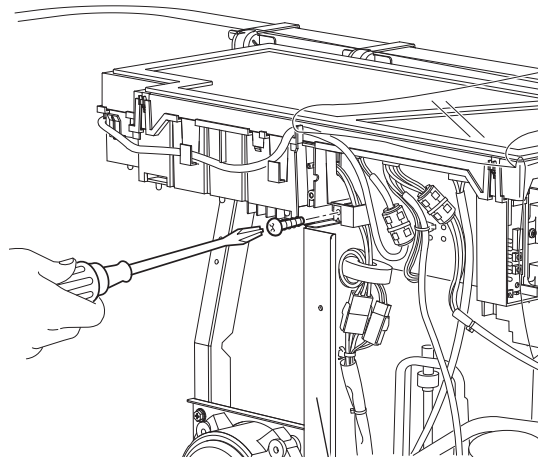

Partition plate (1)

(R9618)

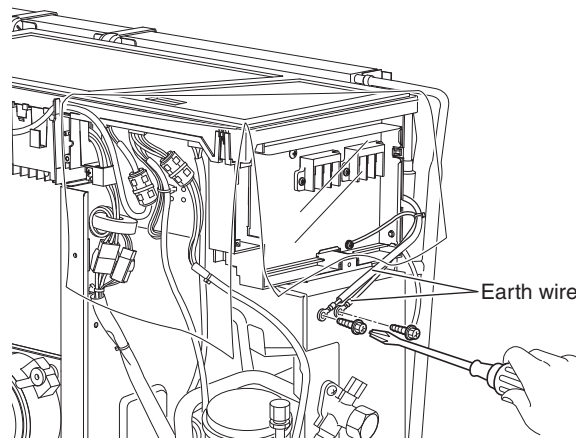

(R9619)

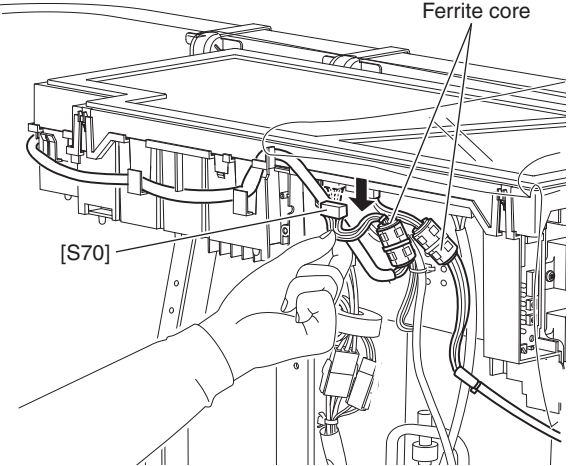
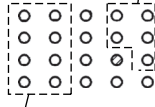
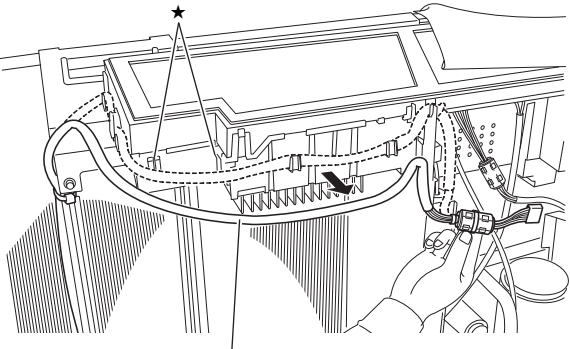
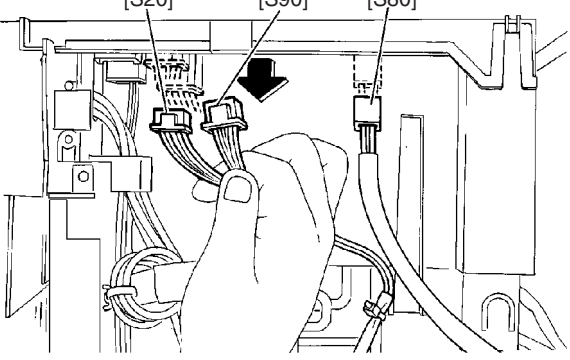
Step	Procedure	Procedure	Points
4	Disconnect the connector for fan motor [S70] and release the 2 ferrite cores attached to the electrical box with clamps.	 <p style="text-align: right;">(R9620)</p>	<ul style="list-style-type: none"> ■ When reassembling, insert the clamp into a small hole. <div style="text-align: center;">  </div> <p style="text-align: right;">(R9878)</p>
5	Release the fan motor lead wire.	 <p style="text-align: right;">(R14466)</p>	<ul style="list-style-type: none"> ■ Fix the ferrite core at where the tension does not pull the PCB assembly when connecting the connectors. ★: When reassembling, do not use these 2 hooks.
6	Disconnect the connectors of the front side.	 <p style="text-align: right;">(R9622)</p>	<p>[S20]: electronic expansion valve coil</p> <p>[S80]: four-way valve coil</p> <p>[S90]: thermistors</p> <ul style="list-style-type: none"> ■ Cooling only models have no harness for [S80].

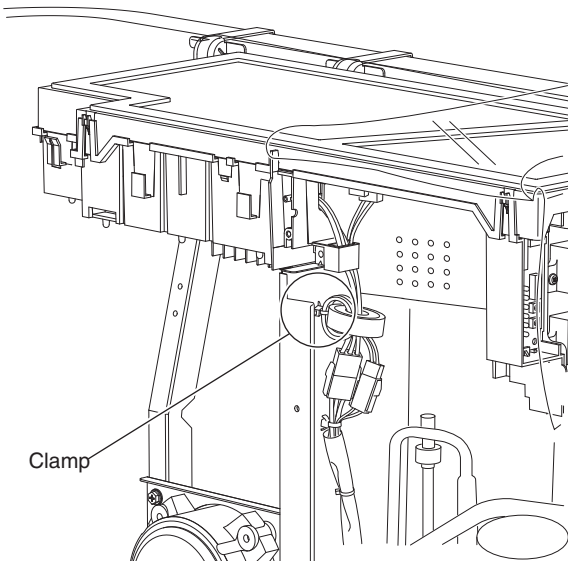
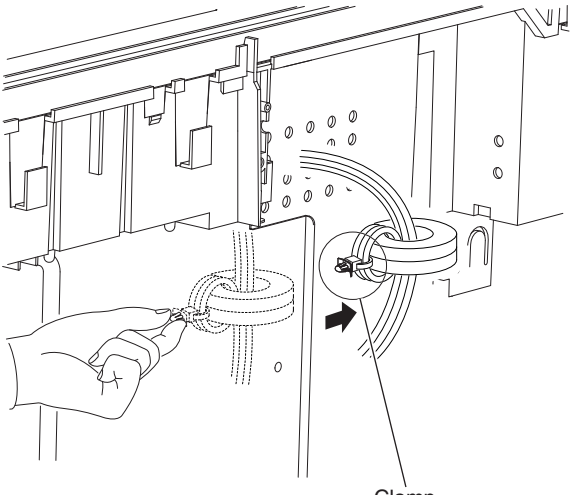
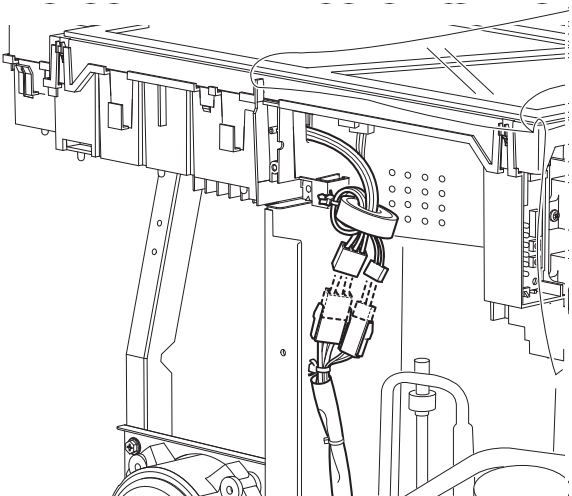
Step	Procedure	Procedure	Points
7	The compressor lead wire is fixed on the partition plate (1) with a clamp.	 <p style="text-align: right;">(R9623)</p>	
8	Pull out the clamp and release the compressor lead wire.	 <p style="text-align: right;">(R9624)</p>	
9	Disconnect the relay connector for the overload protector and the compressor.	 <p style="text-align: right;">(R9625)</p>	

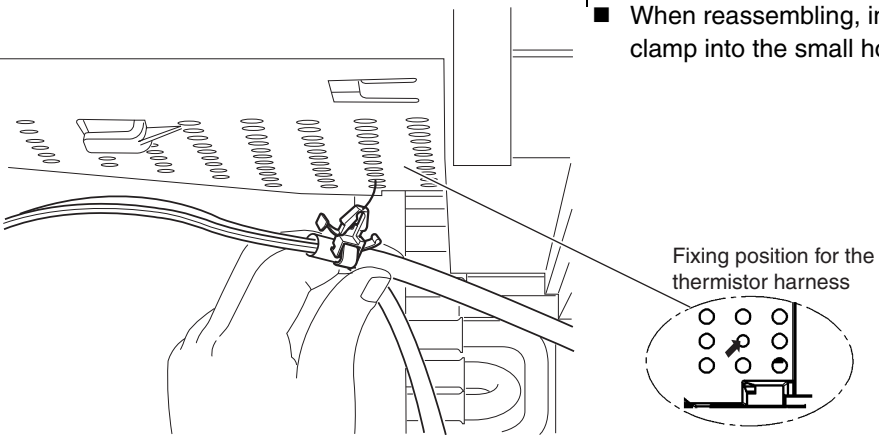
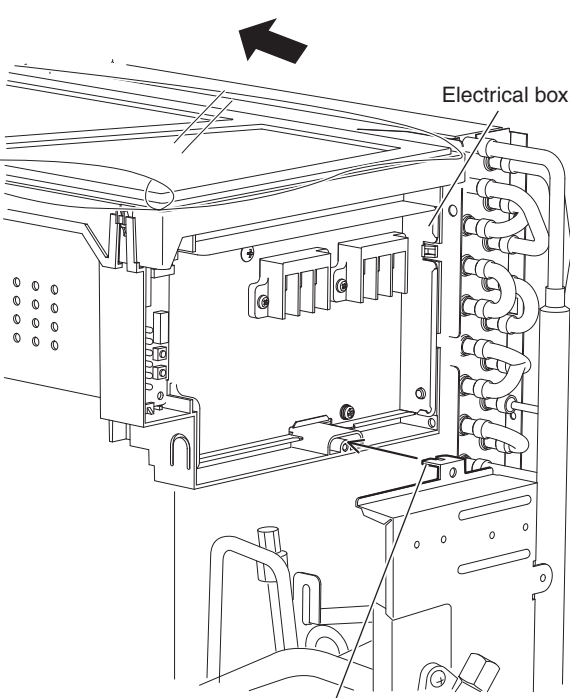
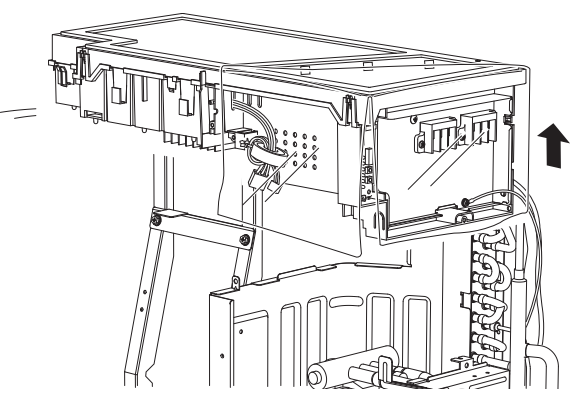
Step	Procedure	Procedure	Points
10	Pull out the clamp of the thermistor harness from under the electrical box.	 <p>(R9626)</p>	<ul style="list-style-type: none"> When reassembling, insert the clamp into the small hole.
11	Slide the electrical box leftward to unfasten the hook on the right side of the box.	 <p>(R9627)</p>	
12	Lift up the electrical box and remove it.	 <p>(R9628)</p>	

2.3 Removal of PCBs

Procedure

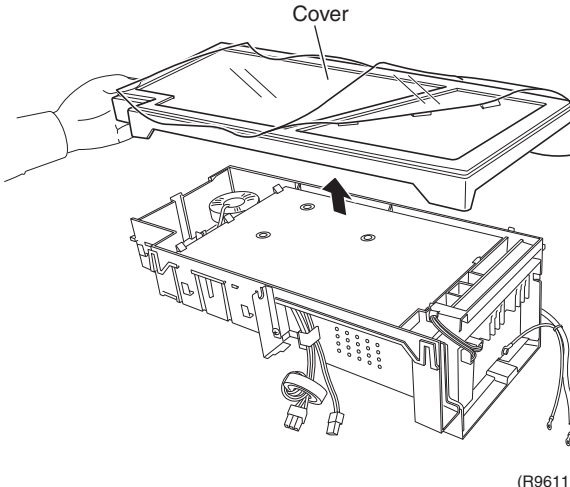
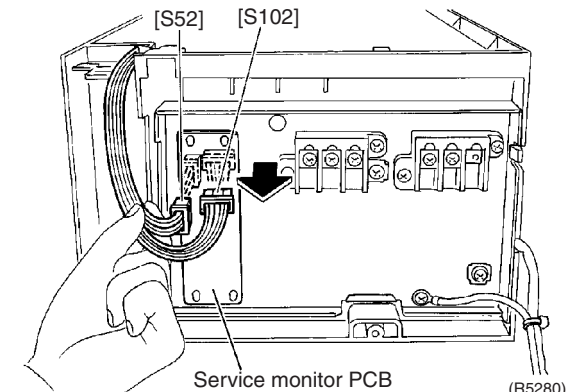
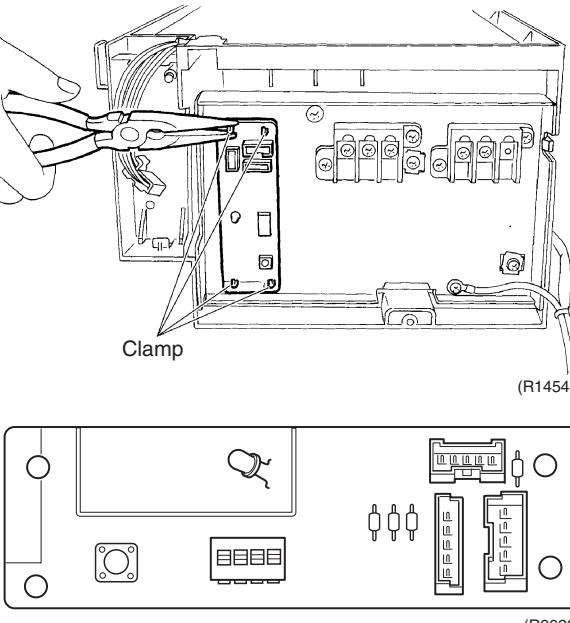

Warning Be sure to wait for 10 minutes or more after turning off all power supplies before disassembling work.

Step	Procedure	Procedure	Points
1	Remove the cover.		<p>Preparation</p> <ul style="list-style-type: none"> Remove the electrical box according to the "Removal of Electrical Box".
2	Disconnect the connectors [S52] [S102] from the service monitor PCB.		
3	Detach the 4 clamps with pliers and remove the service monitor PCB.		

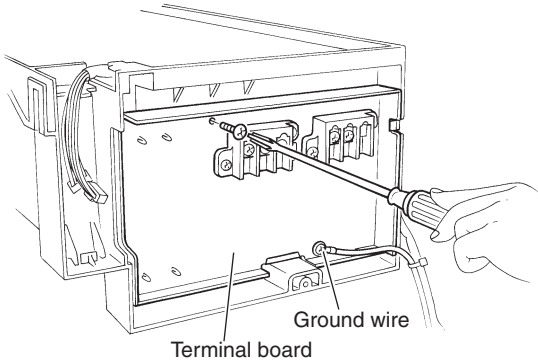
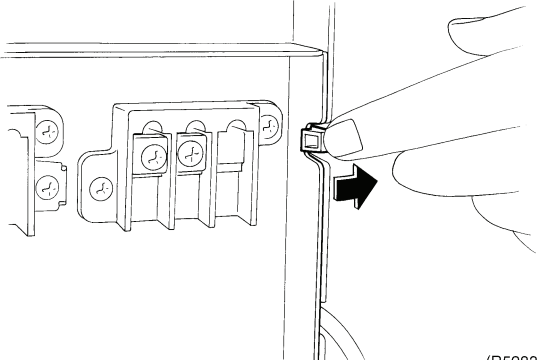
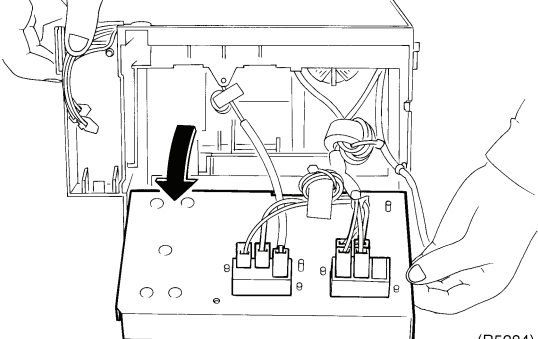
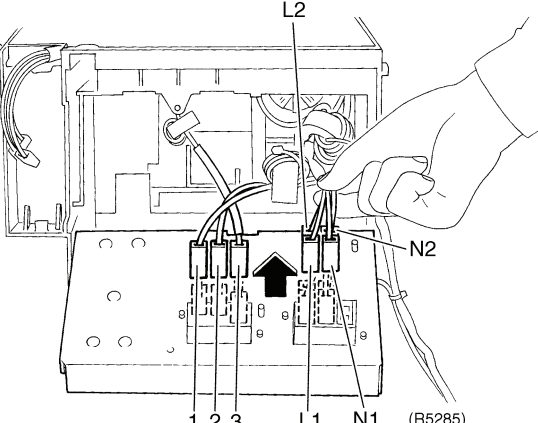
Step	Procedure	Procedure	Points
4	Remove the screws of the terminal board and the ground wire.	 <p>(R5282)</p>	
5	Unfasten the hook on the right.	 <p>(R5283)</p>	
6	Open the terminal board.	 <p>(R5284)</p>	
7	Disconnect the harnesses.	 <p>(R5285)</p>	<p>1: Black 2: White 3: Red L1: Black L2: Brown N1: White N2: Blue</p>

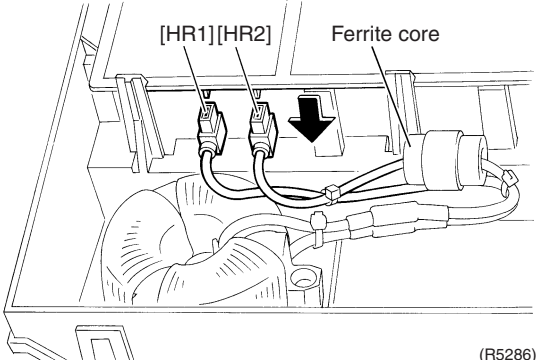
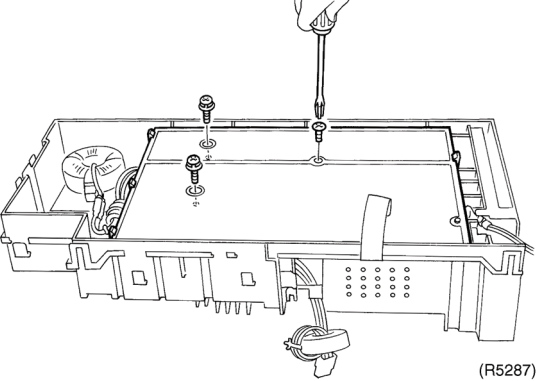
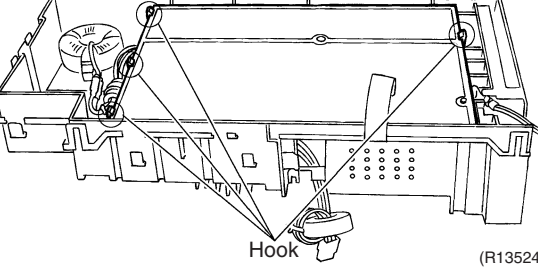
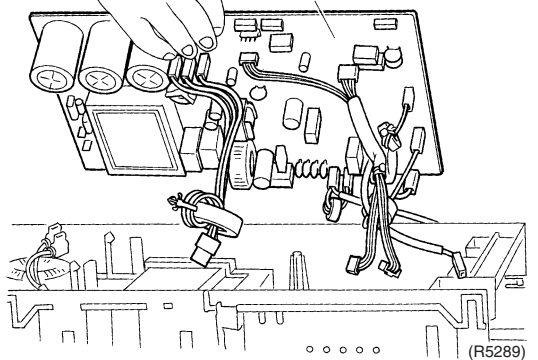
Step	Procedure	Procedure	Points
8	Disconnect the 2 harnesses for the reactor [HR1] [HR2].	 <p>[HR1][HR2] Ferrite core</p> <p>(R5286)</p>	<p>[HR1] : white [HR2] : blue</p> <ul style="list-style-type: none"> ■ The harness for [HR2] has a ferrite core.
9	Remove the 3 screws of the main PCB.	 <p>(R5287)</p>	
10	Release the 4 hooks.	 <p>Hook</p> <p>(R13524)</p>	
11	Lift up and remove the main PCB.	 <p>Main PCB</p> <p>(R5289)</p>	<ul style="list-style-type: none"> ■ See page 11 for detail of the main PCB.

2.4 Removal of Fan Motor

Procedure



Warning Be sure to wait for 10 minutes or more after turning off all power supplies before disassembling work.

Step	Procedure	Procedure	Points
1	Cut the clamps at 2 locations.	<p style="text-align: right;">(R9630)</p>	
2	Remove the 2 lower screws.	<p style="text-align: right;">(R6442)</p>	<ul style="list-style-type: none"> ■ Be sure to remove the lower screws first. If the upper screws are removed first, the fan motor, the center of gravity of which is toward the front, may tilt down or fall, causing injury.
3	Then, remove the 2 upper screws.		
4	Remove the fan motor.	<p style="text-align: right;">(R6443)</p>	<ul style="list-style-type: none"> ■ When reassembling, be sure to place the wire harness lower. <p style="text-align: right;">(R6444)</p>

2.5 Removal of Coils / Thermistors

Procedure

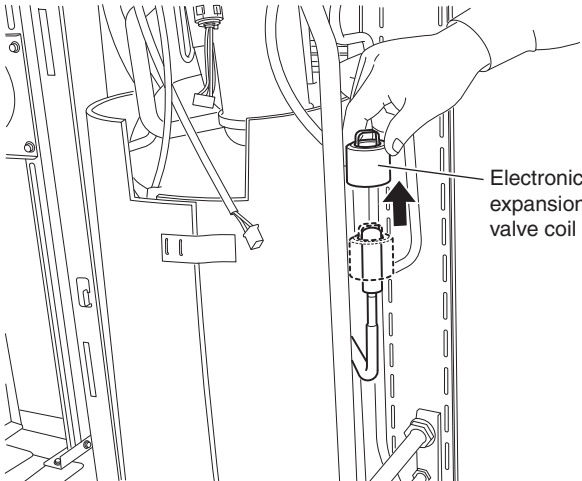
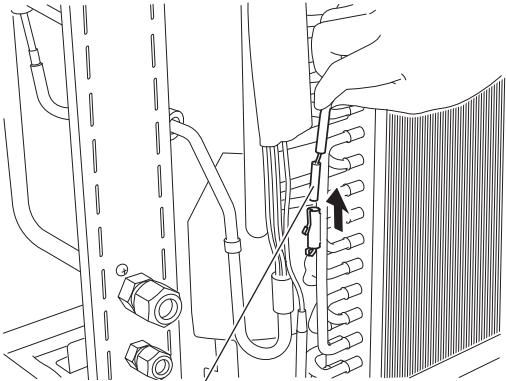
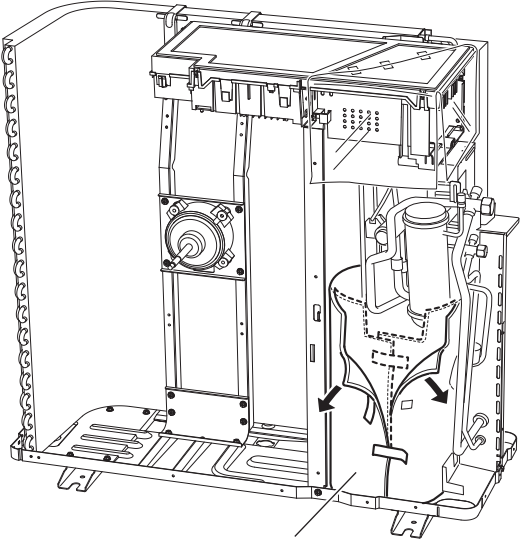

Warning Be sure to wait for 10 minutes or more after turning off all power supplies before disassembling work.

Step	Procedure	Points
<p>1. Remove the electronic expansion valve coil.</p> <p>1 Pull the electronic expansion valve coil out of position.</p>	 <p style="text-align: right;">Electronic expansion valve coil</p> <p style="text-align: right;">(R9631)</p>	
<p>2. Remove the thermistors.</p> <p>1 Pull out the outdoor heat exchanger thermistor.</p> <p>2 Slightly open the sound blanket (outer).</p>	 <p style="text-align: center;">Outdoor heat exchanger thermistor (R9632)</p>  <p style="text-align: center;">Sound blanket (outer) (R9633)</p>	

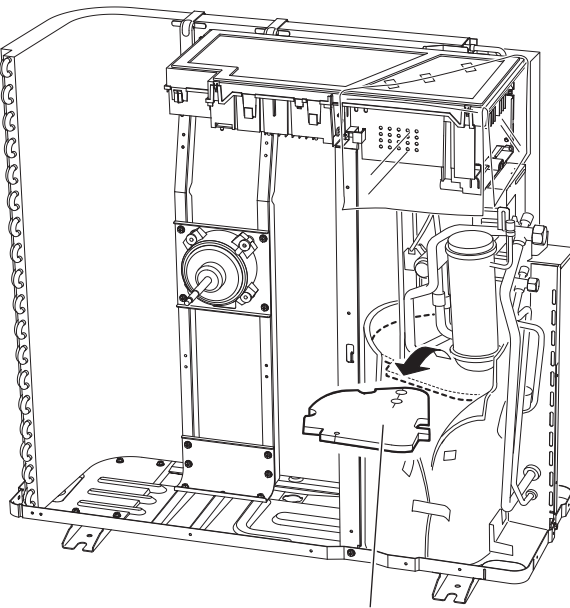
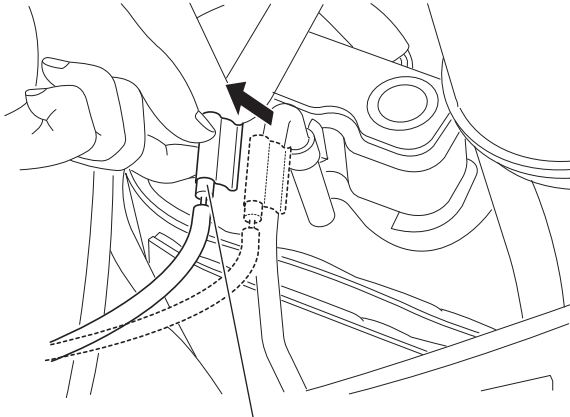
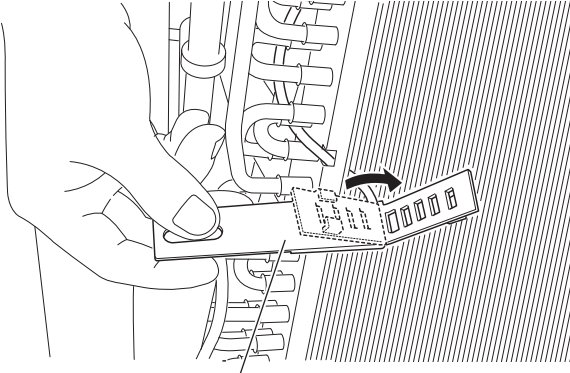
Step		Procedure	Points
3	Remove the sound blanket (top upper).	 <p data-bbox="813 829 1040 877">Sound blanket (top upper) (R9634)</p>	
4	Remove the discharge pipe thermistor.	 <p data-bbox="732 1346 1060 1373">Discharge pipe thermistor (R9635)</p>	
5	At the back side, open the outdoor temperature thermistor holder.	 <p data-bbox="602 1797 1060 1824">Outdoor temperature thermistor holder (R9636)</p>	

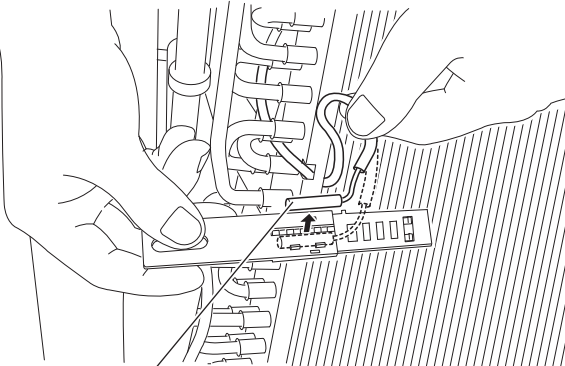
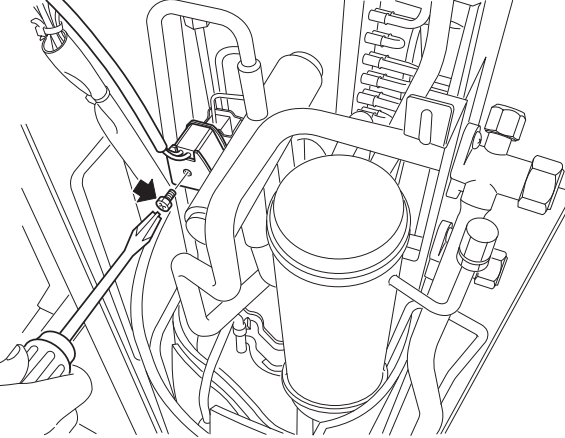
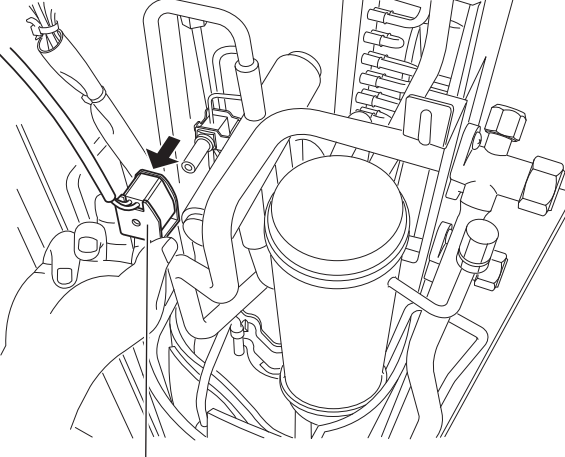
Step		Procedure	Points
6	Release the outdoor temperature thermistor.	 <p style="text-align: center;">Outdoor temperature thermistor (R9637)</p>	
3.	Remove the four-way valve coil.		
1	Remove the screw.	 <p style="text-align: right;">(R9638)</p>	
2	Remove the four-way valve coil.	 <p style="text-align: center;">Four way valve coil (R9639)</p>	

2.6 Removal of Sound Blankets

Procedure

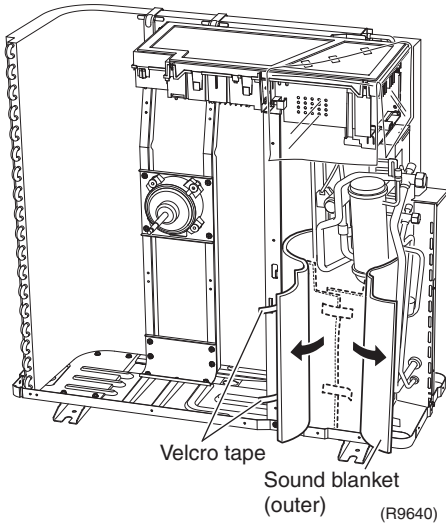
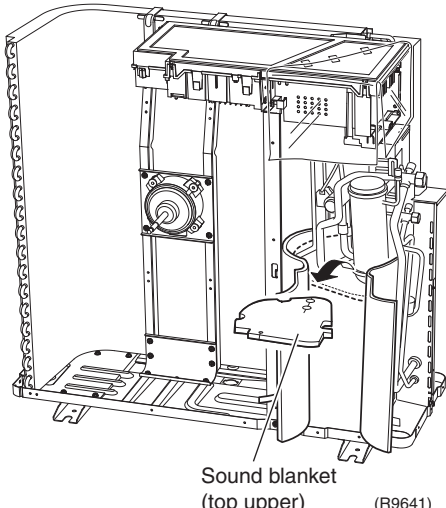
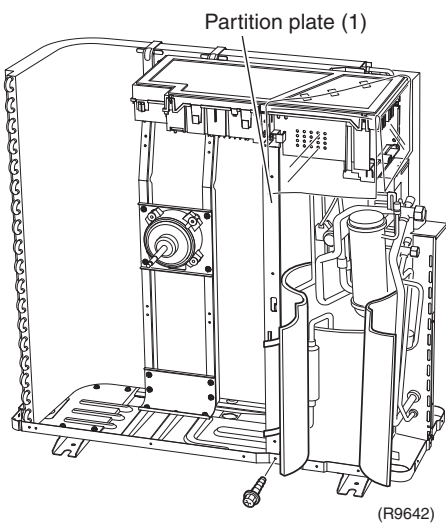

Warning Be sure to wait for 10 minutes or more after turning off all power supplies before disassembling work.

Step	Procedure	Points
1	<p>Open the sound blanket (outer).</p> 	
2	<p>Remove the sound blanket (top upper).</p> 	<ul style="list-style-type: none"> ■ The sound blanket is fragile. Carefully pass the discharge pipe through it.
3	<p>Remove the screw and open the partition plate (1) slightly to the left for easy work.</p> 	

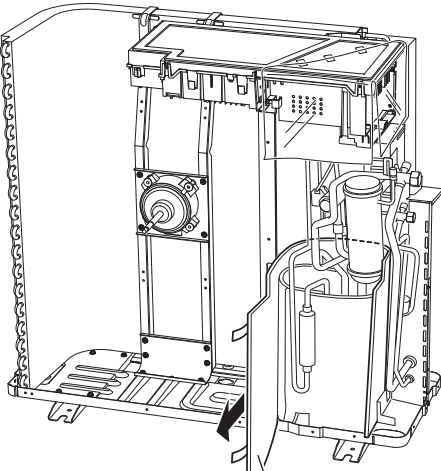
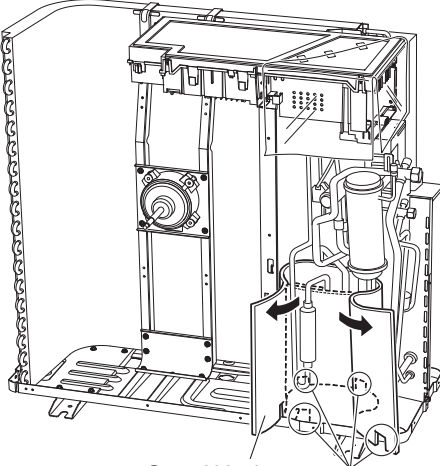
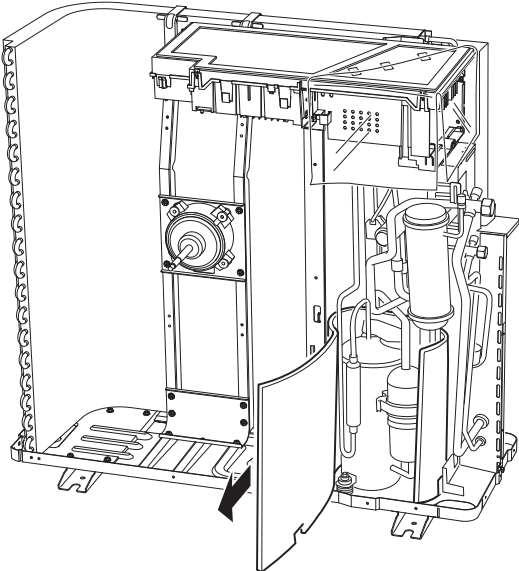
Step	Procedure	Procedure	Points
4	Remove the sound blanket (outer).	 <p>Sound blanket (outer) (R9643)</p>	
5	Open the sound blanket (inner).	 <p>Sound blanket (inner) Compressor mount (R9644)</p>	
6	Remove the sound blanket (inner).	 <p>(R9645)</p>	<p>■ The sound blanket is fragile. Be careful of the notches of the compressor mount (4 locations).</p>

2.7 Removal of Compressor

Procedure

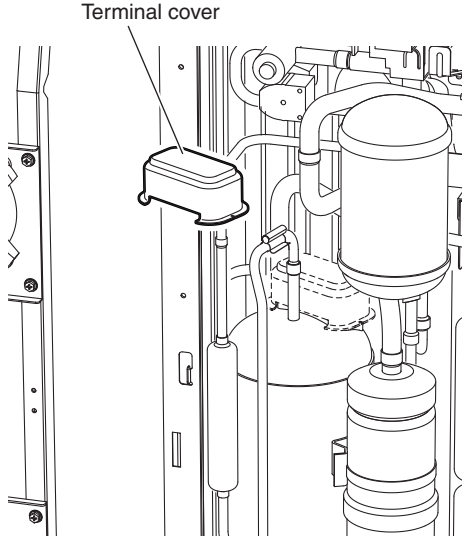
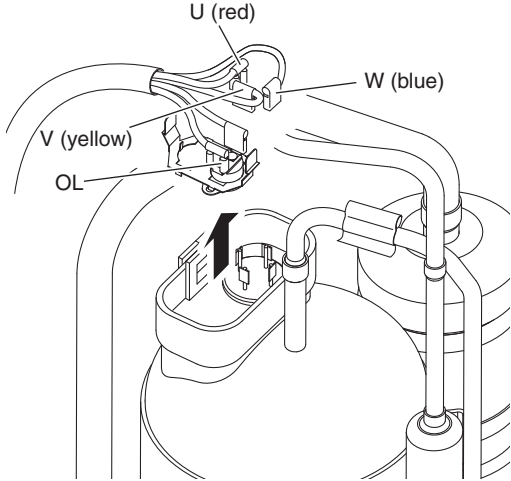

Warning Be sure to wait for 10 minutes or more after turning off all power supplies before disassembling work.

Step	Procedure	Points
1	Remove the terminal cover.  <p style="text-align: right;">(R9650)</p>	
2	Pull out the 3 lead wires.	■ U: red, V: yellow, W: blue
3	Remove the overload protector (OL).  <p style="text-align: right;">(R9471)</p>	

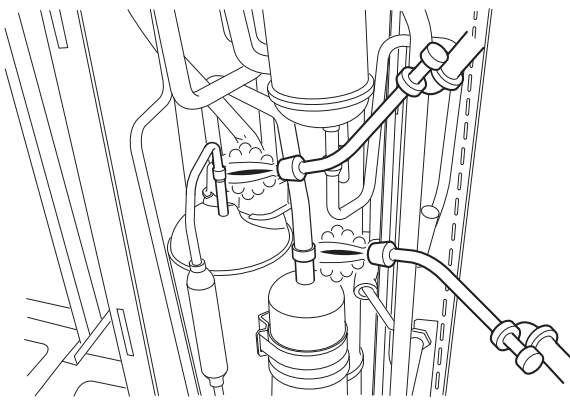
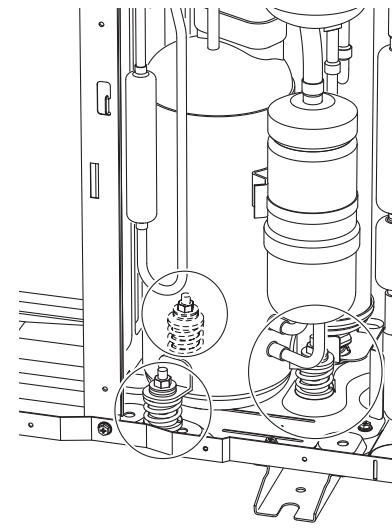
Step	Procedure	Points
<ul style="list-style-type: none"> ■ Before working, make sure that the refrigerant gas is empty in the circuit. ■ Be sure to apply nitrogen replacement when heating up the brazed part. 	 <p style="text-align: right;">(R9646)</p>	<p>Warning Be careful not to burn yourself with the pipes and other parts that are heated by the gas brazing machine.</p> <p>Warning If the refrigerant gas leaks during work, ventilate the room. If the refrigerant gas is exposed to flames, toxic gas may be generated.</p>
<p>4 Heat up the brazed part and withdraw the piping with pliers.</p>		<p>Warning Prepare a wet cloth to extinguish a fire immediately in case the refrigerant oil in the compressor happens to ignite.</p>
<p>5 Remove the 3 nuts.</p>	 <p style="text-align: right;">(R7021)</p>	<p>Caution For global environment protection, do not discharge the refrigerant gas in the atmosphere. Make sure to collect all the refrigerant gas.</p> <p>Cautions for restoration</p> <ol style="list-style-type: none"> 1. Restore the piping by non-oxidation brazing. 2. It is required to prevent the carbonization of the oil inside the four-way valve to prevent deterioration of the gaskets affected by heat. Keep below 120°C/248°F by wrapping the four-way valve with a wet cloth and keeping water handy so that the cloth does not dry.
<p>Note:</p> <ul style="list-style-type: none"> ■ Never use a metal saw for cutting pipes to prevent saw dust from entering the circuit. ■ When withdrawing the pipes, be careful not to pinch them firmly with pliers. The pipes may get deformed. ■ Provide a protective sheet or a steel plate so that the brazing flame cannot influence peripheries. ■ Be careful not to burn the compressor terminals, the name plate, or the heat exchanger fin. 		<p>In case of difficulty with gas brazing machine</p> <ol style="list-style-type: none"> 1. Disconnect the brazed part where is easy to disconnect and restore. 2. Cut pipes on the main unit with a tube cutter in order to make it easy to disconnect.

Part 8

Trial Operation and Field Settings

1. Pump Down Operation	182
2. Forced Cooling Operation	183
3. Trial Operation	184
4. Field Settings	185
4.1 Model Type Setting	185
4.2 Temperature Display Switch	185
4.3 When 2 Units are Installed in 1 Room.....	186
4.4 Facility Setting Switch (cooling at low outdoor temperature).....	187
4.5 Jumper and Switch Settings.....	187
5. Application of Silicon Grease to a Power Transistor and a Diode Bridge.....	188

1. Pump Down Operation

Outline

In order to protect the environment, be sure to conduct pump down operation when relocating or disposing the unit.

Detail

- 1) Remove the valve caps from the liquid stop valve and the gas stop valve.
- 2) Carry out forced cooling operation.
- 3) After 5 to 10 minutes, close the liquid stop valve with a hexagonal wrench.
- 4) After 2 to 3 minutes, close the gas stop valve and stop the forced cooling operation.

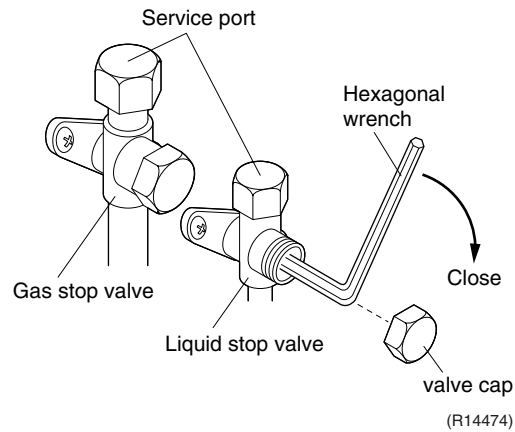

Refer to page183 for forced cooling operation.

2. Forced Cooling Operation

Item	Forced Cooling
Conditions	The forced cooling operation is allowed when both the following conditions are met. 1) The outdoor unit is not abnormal and not in the 3-minute standby mode. 2) The outdoor unit is not operating.
Start	The forced cooling operation starts when any of the following conditions is fulfilled. 1) Press the forced cooling operation ON/OFF button (SW1) on the indoor unit for 5 seconds. 2) Press the forced cooling operation ON/OFF button (SW1) on the outdoor unit.
Command frequency	55 Hz
End	The forced cooling operation ends when any of the following conditions is fulfilled. 1) The operation ends automatically after 15 minutes. 2) Press the forced cooling operation ON/OFF button (SW1) on the indoor unit again. 3) Press the ON/OFF button on the remote controller. 4) Press the forced cooling operation ON/OFF button (SW1) on the outdoor unit.
Others	The protection functions are prior to all others in the forced cooling operation.

Indoor Unit

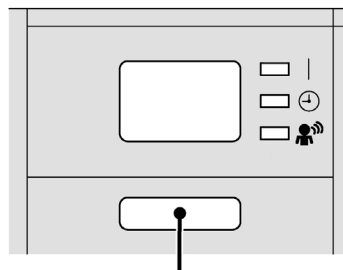

ON/OFF button (SW1) (R14145)

Outdoor Unit

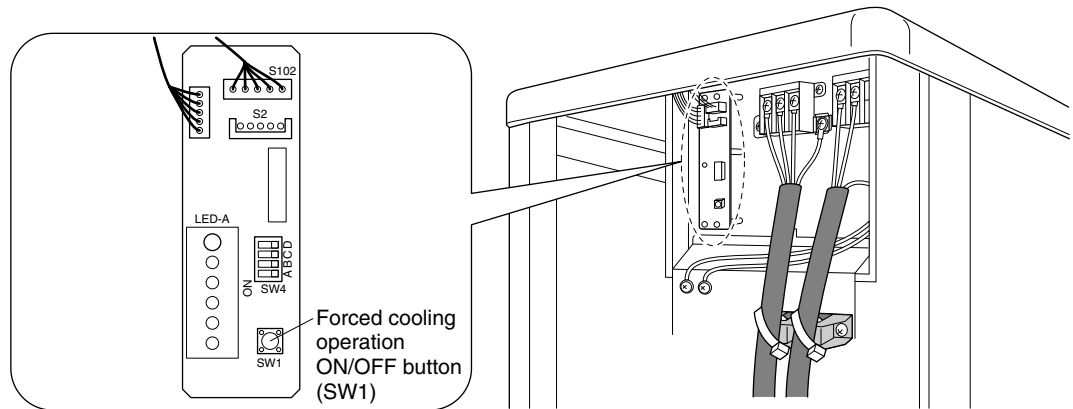

(R14475)

3. Trial Operation

Outline

1. Measure the supply voltage and make sure that it falls in the specified range.
2. Trial operation should be carried out in either cooling or heating mode.
3. Carry out the trial operation in accordance with the operation manual to ensure that all functions and parts, such as louver movement, are working properly.
 - The air conditioner requires a small amount of power in its standby mode. If the system is not to be used for some time after installation, shut off the circuit breaker to eliminate unnecessary power consumption.
 - If the circuit breaker trips to shut off the power to the air conditioner, the system backs up the operation mode. The system then restarts operation with the previous mode when the circuit breaker is restored.

In cooling mode, select the lowest programmable temperature; in heating mode, select the highest programmable temperature.

- Trial operation may be disabled in either mode depending on the room temperature.
- After trial operation is complete, set the temperature to a normal level.
(26 ~ 28°C (78.8 ~ 82.4°F) in cooling mode, 20 ~ 24°C (68 ~ 75.2°F) in heating mode)
- For protection, the system does not start for 3 minutes after it is turned off.

Detail

ARC452 Series

- (1) Press the ON/OFF button to turn on the system.
- (2) Press the both of TEMP buttons and the MODE button at the same time.
- (3) Press the MODE button twice.
(? appears on the display to indicate that trial operation is selected.)
- (4) Press the MODE button and select operation mode.
- (5) Trial operation terminates in approx. 30 minutes and switches into normal mode. To quit a trial operation, press the ON/OFF button.

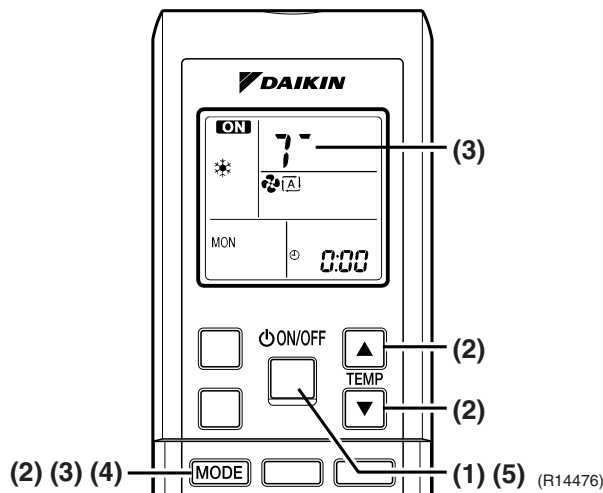

4. Field Settings

4.1 Model Type Setting

ARC452A21

- This remote controller is common to the heat pump model and cooling only model. Use the DIP switch on the remote controller to set the heat pump model or cooling only model.
- Make the setting as shown in the illustration. (The factory set is the heat pump side.)
 - Heat pump model: Set the DIP switch to H/P.
 - Cooling only model: Set the DIP switch to C/O.

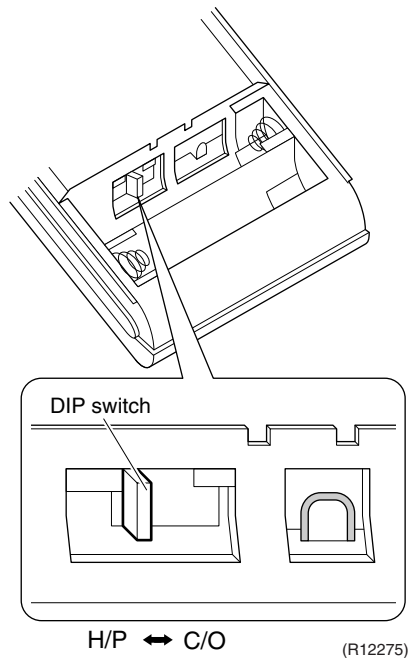

4.2 Temperature Display Switch

- You can select Fahrenheit or Celsius for temperature display.
- Press the TEMP▲ and ▼ buttons simultaneously for 5 seconds to change the unit of temperature display.

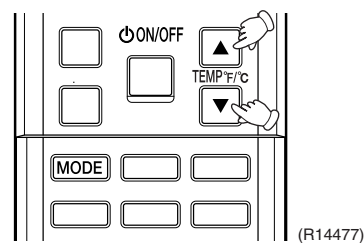

4.3 When 2 Units are Installed in 1 Room

When 2 indoor units are installed in 1 room, 1 of the 2 pairs of indoor unit and wireless remote controller can be set for different addresses.

Both the indoor unit PCB and the wireless remote controller need alteration.

Indoor Unit PCB

- Cut the address-setting jumper JA on the control PCB.

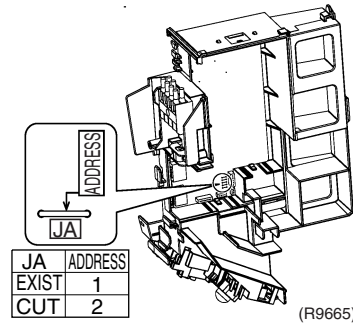

Wireless Remote Controller

- Cut the address-setting jumper.

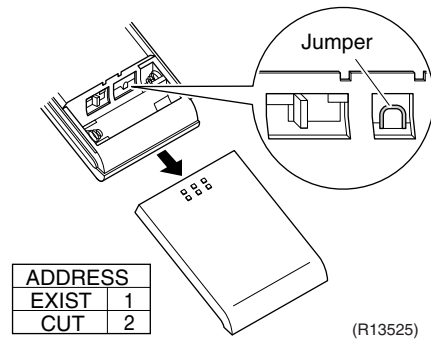

4.4 Facility Setting Switch (cooling at low outdoor temperature)

Outline This function is limited to facilities where the target of air conditioning is equipment. Never use it in a residence or office occupied by people.

Detail

- You can expand the cooling operation range from -10°C (14°F : normal operation) to -15°C (5°F : cooling at low outdoor temperature setting) by turning on the switch (SW4-B) on the outdoor unit PCB.
- When the target fan speed determined by the control to maintain pressure difference remains under 150 ~ 250 rpm (depending on the model) for about 30 seconds, the fan is turned off to maintain the pressure difference. When the pressure difference returns to high again, the fan starts to rotate again.

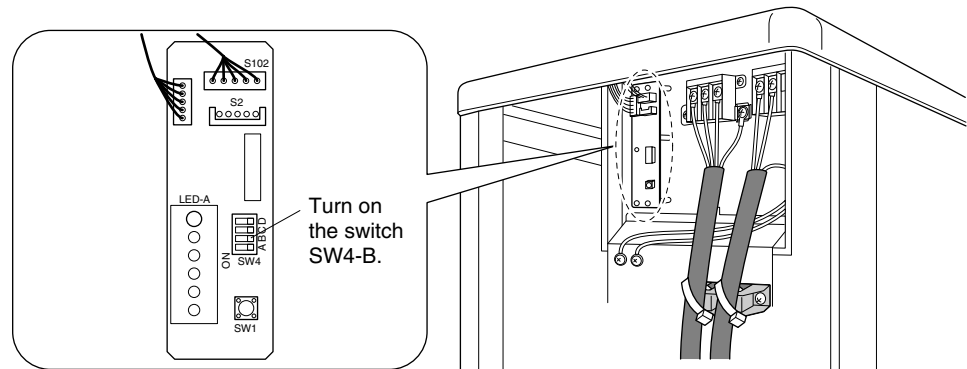

(R14478)



Caution

1. If the outdoor unit is installed where the outdoor heat exchanger of the unit is exposed to direct wind, provide a windbreak wall.
2. Intermittent noises may be produced by the indoor unit due to the outdoor fan turning on and off when using facility settings.
3. Do not place humidifiers or other items which might raise the humidity in rooms where facility settings are being used.
A humidifier might cause dew jumping from the indoor unit outlet vent.
4. Use the indoor unit at the highest level of airflow rate.

4.5 Jumper and Switch Settings

Jumper	Function	When connected (factory set)	When cut
JB (on indoor unit PCB)	Fan speed setting when compressor stops for thermostat OFF. (effective only at cooling operation)	Fan speed setting; Remote controller setting	Fan rpm is set to "0" <Fan stop>
JC (on indoor unit PCB)	Power failure recovery function	Auto-restart	The unit does not resume operation after recovering from a power failure. Timer ON/OFF settings are cleared.

Switch	Function	OFF (factory set)	ON
SW4-C (on outdoor unit PCB)	Improvement of defrost performance	Standard control	Reinforced control (ex. The frequency increases, the duration time of defrost lengthens.)



For the location of the jumper and the switch, refer to the following pages.

- Indoor unit; page 8
- Outdoor unit; page 11

5. Application of Silicon Grease to a Power Transistor and a Diode Bridge

Applicable Models

All outdoor units using inverter type compressor for room air conditioner.

When the printed circuit board (PCB) of an outdoor unit is replaced, it is required that silicon grease (*1) is certainly applied to the heat radiation part (the contact point to the radiation fin) of the power transistor and diode bridge.

*1: Parts number of the silicon grease – 1172698 (Drawing number 3FB03758-1)

Details

The silicon grease is an essential article for encouraging the heat radiation of the power transistor and the diode bridge. Applying the paste should be implemented in accordance with the following instruction.

NOTE: There is the possibility of failure with smoke in case of bad heat radiation.

- Wipe off the old silicon grease completely on a radiation fin.
- Apply the silicon grease evenly to the whole.
- Do not leave any foreign object such as solder or paper waste between the power transistor and the radiation fin, and also the diode bridge, and the radiation fin.
- Tighten the screws of the power transistor and the diode bridge, and contact to the radiation fin without any gap.

<Example>

The shape of electrical box and PCB vary depending on the model.

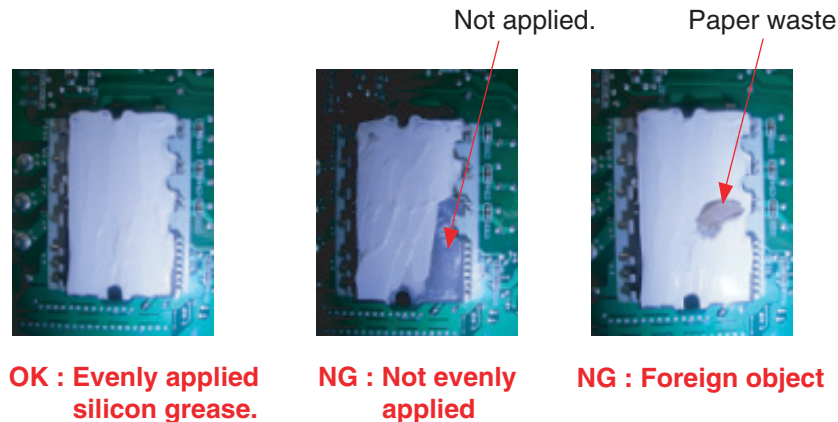
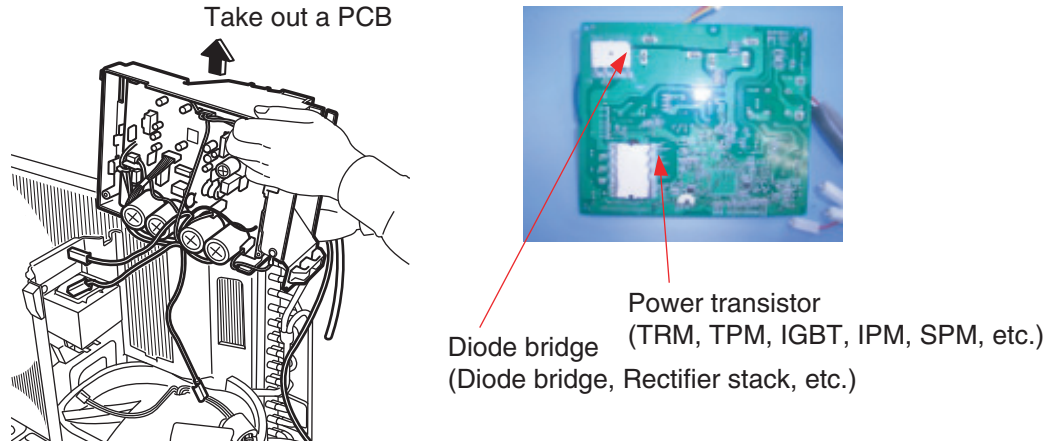

(R9056)

Part 9 Appendix

1. Piping Diagrams.....	190
1.1 Indoor unit	190
1.2 Outdoor Unit.....	191
2. Wiring Diagrams.....	192

1. Piping Diagrams

1.1 Indoor unit

FTXS30/36HVJU

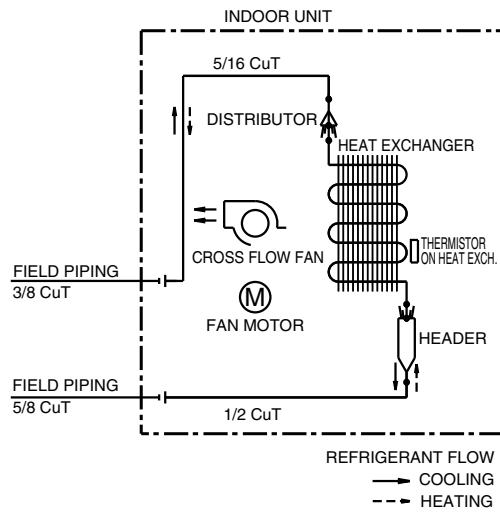

4D062742

1.2 Outdoor Unit

RKS30/36HVJU

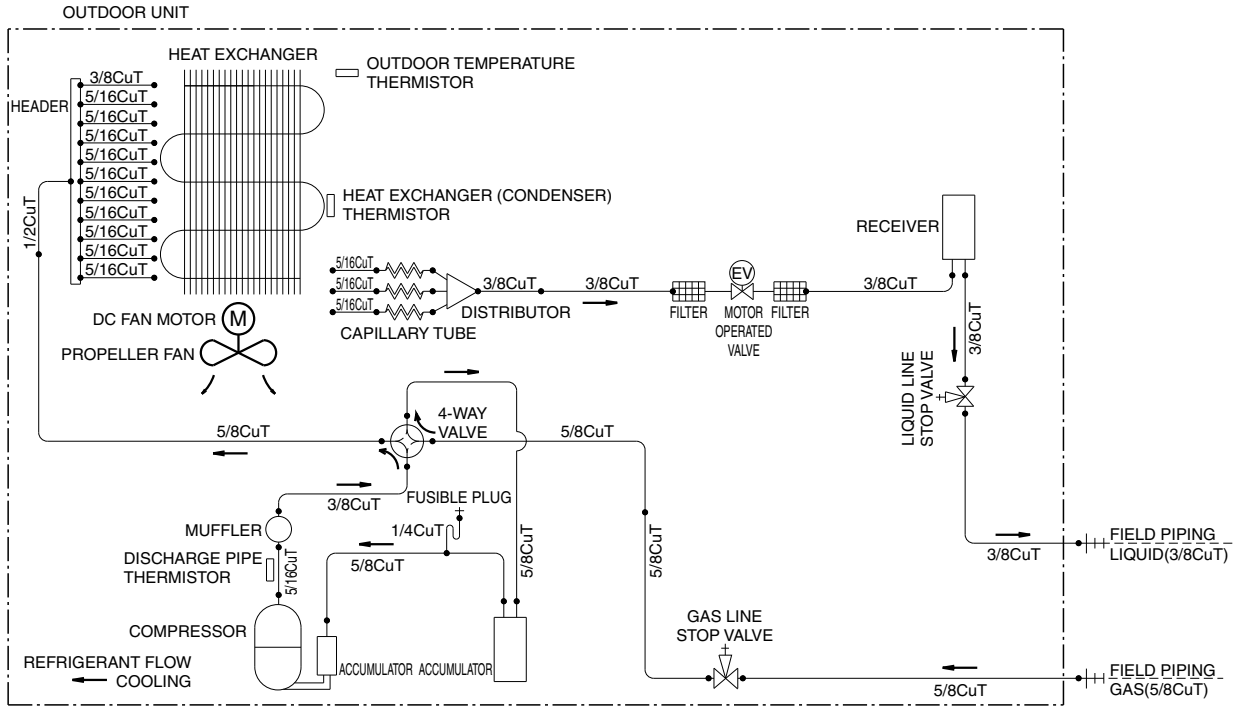

3D071132A

RXS30/36HVJU

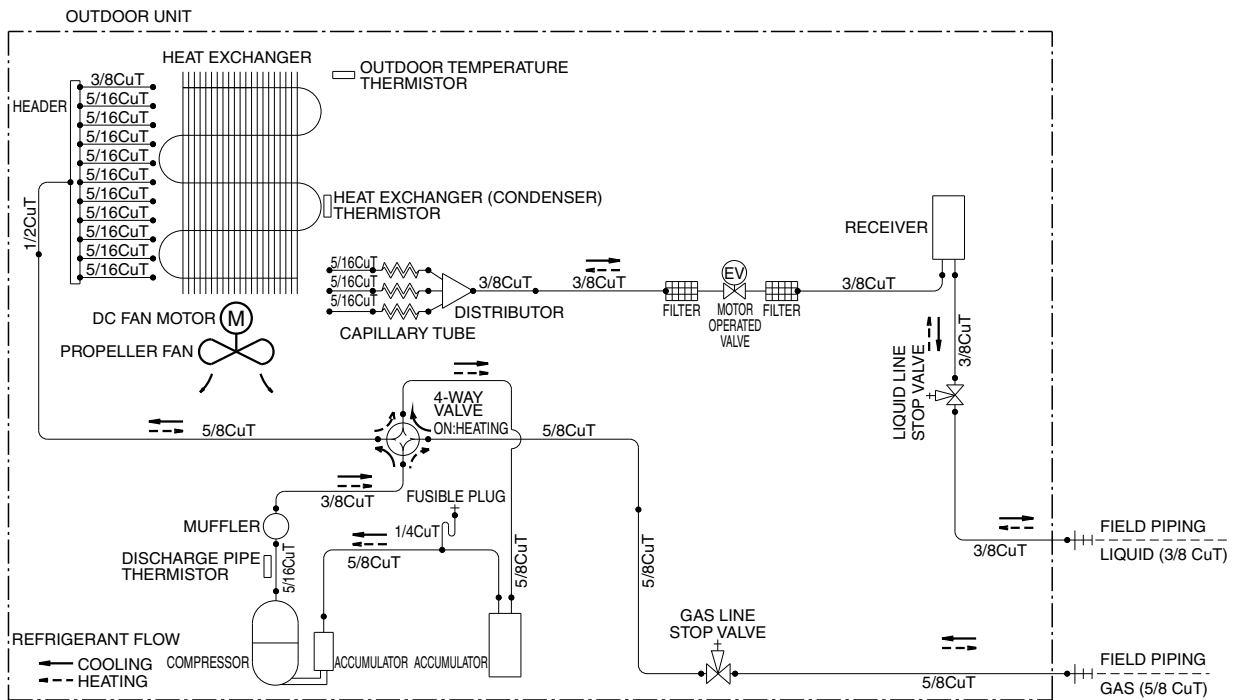

3D063153

2. Wiring Diagrams

FTXS30/36HVJU

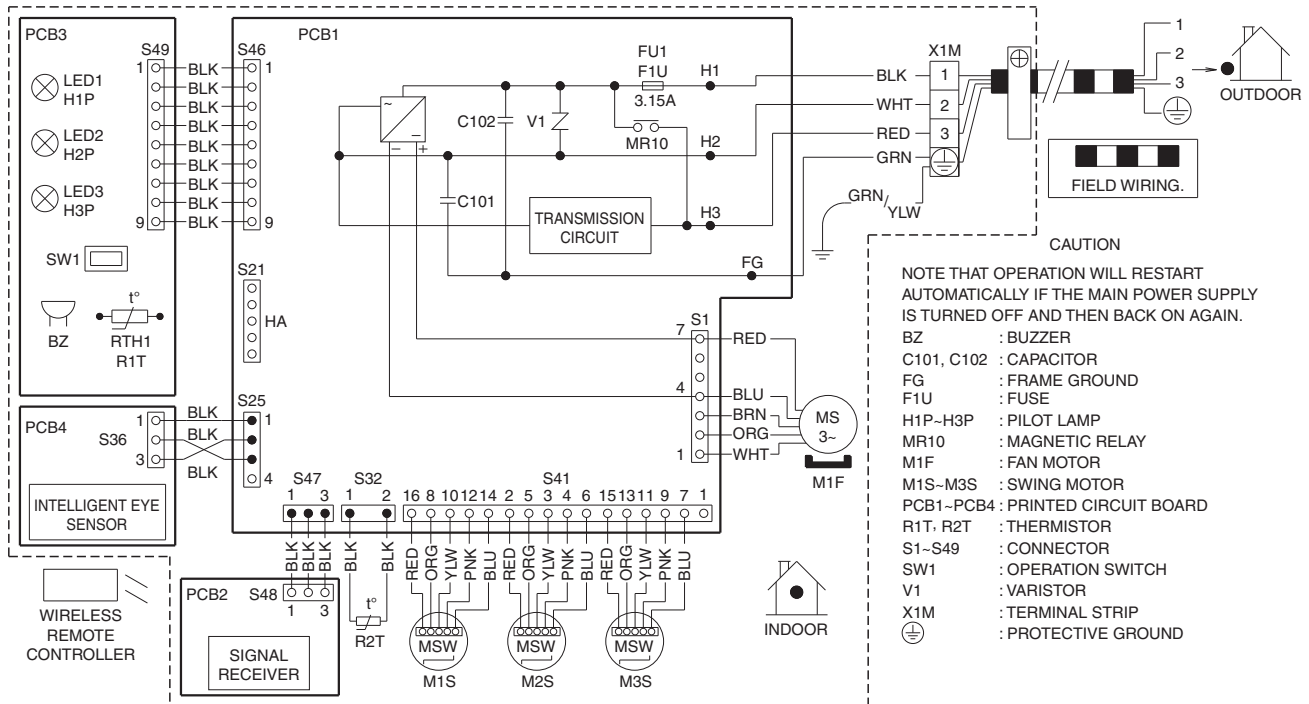

C: 3D060942C

RKS30/36HVJU, RXS30/36HVJU

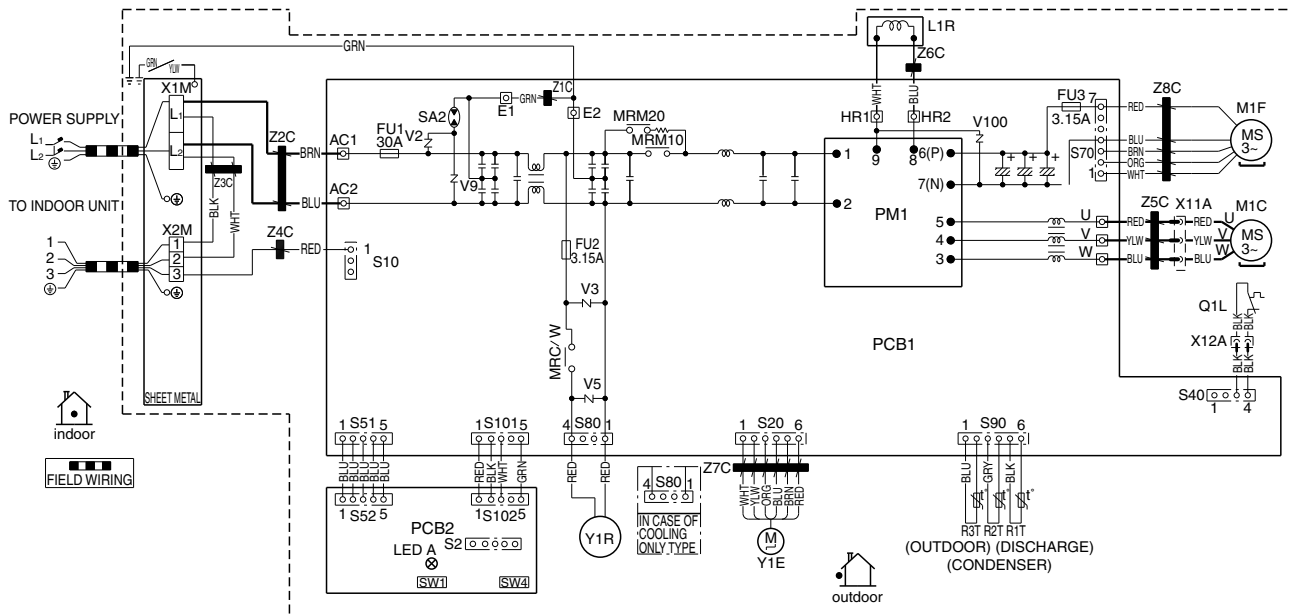

- | | | | |
|---------------------------------------|-------------------------------|--|---|
| Z1C~Z8C : FERRITE CORE | MRM10, MRM20 : MAGNETIC RELAY | L1, L2 : LIVE | M1C : COMPRESSOR MOTOR |
| X1M, X2M : TERMINAL STRIP | MRC/W : THERMISTOR | SW1 : FORCED OPERATION ON/OFF SW (SW1) | M1F : FAN MOTOR |
| Y1E : ELECTRONIC EXPANSION VALVE COIL | R1T~R3T : THERMISTOR | SW4 : LOCAL SETTING SW (SW4) | L1R : REACTOR |
| V2, V3, V5, V9, V100 : VARISTOR | S2~S102 : CONNECTOR | | Q1L : OVERLOAD PROTECTOR |
| SA2 : SURGE ARRESTER | LEDA : PILOT LAMP | | PM1 : POWER MODULE |
| FU1, FU2, FU3 : FUSE | | | PCB1, 2 : PRINTED CIRCUIT BOARD |
| AC1, AC2 : FUSE | | | U, V, W, X11A, X12A : REVERSING SOLENOID VALVE COIL |
| E, E2 : CONNECTOR | | | Y1R : REVERSING SOLENOID VALVE COIL |
| HR1, HR2 : CONNECTOR | | | SHEET METAL : TERMINAL STRIP FIXED PLATE |

3D062017B

Warning



Daikin Industries, Ltd.'s products are manufactured for export to numerous countries throughout the world. Daikin Industries, Ltd. does not have control over which products are exported to and used in a particular country. Prior to purchase, please therefore confirm with your local authorized importer, distributor and/or retailer whether this product conforms to the applicable standards, and is suitable for use, in the region where the product will be used. This statement does not purport to exclude, restrict or modify the application of any local legislation.

Ask a qualified installer or contractor to install this product. Do not try to install the product yourself. Improper installation can result in water or refrigerant leakage, electrical shock, fire, or explosion.

Use only those parts and accessories supplied or specified by Daikin. Ask a qualified installer or contractor to install those parts and accessories. Use of unauthorized parts and accessories or improper installation of parts and accessories can result in water or refrigerant leakage, electrical shock, fire, or explosion.

Read the User's Manual carefully before using this product. The User's Manual provides important safety instructions and warnings. Be sure to follow these instructions and warnings.

If you have any inquiries, please contact your local importer, distributor, or retailer.



©2011 Daikin Industries, Limited.

Daikin, Daikin AC Absolute Comfort and its design, VRV, REFNET, and Quaternary, Daikin Altherma are trademarks of Daikin Industries, Limited.



JMI-0107



JQA-1452

About ISO 9001

ISO 9001 is a plant certification system defined by the International Organization for Standardization (ISO) relating to quality assurance. ISO 9001 certification covers quality assurance aspects related to the "design, development, manufacture, installation, and supplementary service" of products manufactured at the plant.



EC99J2044

About ISO 14001

ISO 14001 is the standard defined by the International Organization for Standardization (ISO) relating to environmental management systems. Our group has been acknowledged by an internationally accredited program of environmental protection procedures and activities to meet the requirements of ISO 14001.

Dealer

DAIKIN AC (AMERICAS), INC.

1645 Wallace Drive, Suite 110
Carrollton, TX 75006
info@daikinac.com
www.daikinac.com

©All rights reserved

•Specifications, designs and other content appearing in this brochure are current as of July 2011 but subject to change without notice.